

INGERSOLL LUFT- UND RAUMFAHRT
INGERSOLL AIRCRAFT AND AEROSPACE





Ingersoll Werkzeuge GmbH ist der Spezialist für extrem weichschneidende Fräswerkzeuge in Standard- und Sonderausführung.

Zusammen mit den sehr erfolgreichen Lösungen für die Luft- und Raumfahrt, sowie der projektorientierten Entwicklung von speziellen Werkzeuglösungen bieten wir ein umfassendes Technologie-Potenzial, das von den unterschiedlichsten Branchen genutzt wird. Dabei ist die enge Kooperation mit unseren Kunden bei der Entwicklung von technisch anspruchsvollen Problemlösungen die Basis langjähriger und dauerhafter Partnerschaften – weltweit. Sowohl kleine und mittelständische Unternehmen als auch international agierende Konzerne vertrauen unserer fachlichen Qualifikation und profitieren von der Zuverlässigkeit und Prozesssicherheit unserer Werkzeuge.

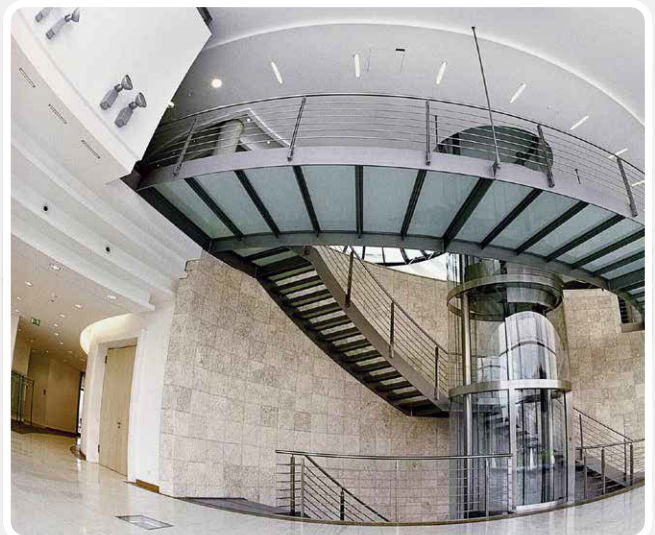



Ingersoll Werkzeuge GmbH is specialized in the production of cutting tools with an excellent vibration-free performance in both standard and special-purpose design.

In addition to very successful solutions for milling and the project-oriented development of special cutting tool solutions, we offer a whole range of technology potential which is applied by the most various industries. The close cooperation with our customers for the development of technically demanding solutions for machining problems is the basis of long-term and durable partnerships – worldwide. Small as well as medium-sized companies but also international enterprises trust our professional qualification and profit from the reliability and process security of our cutting tools.

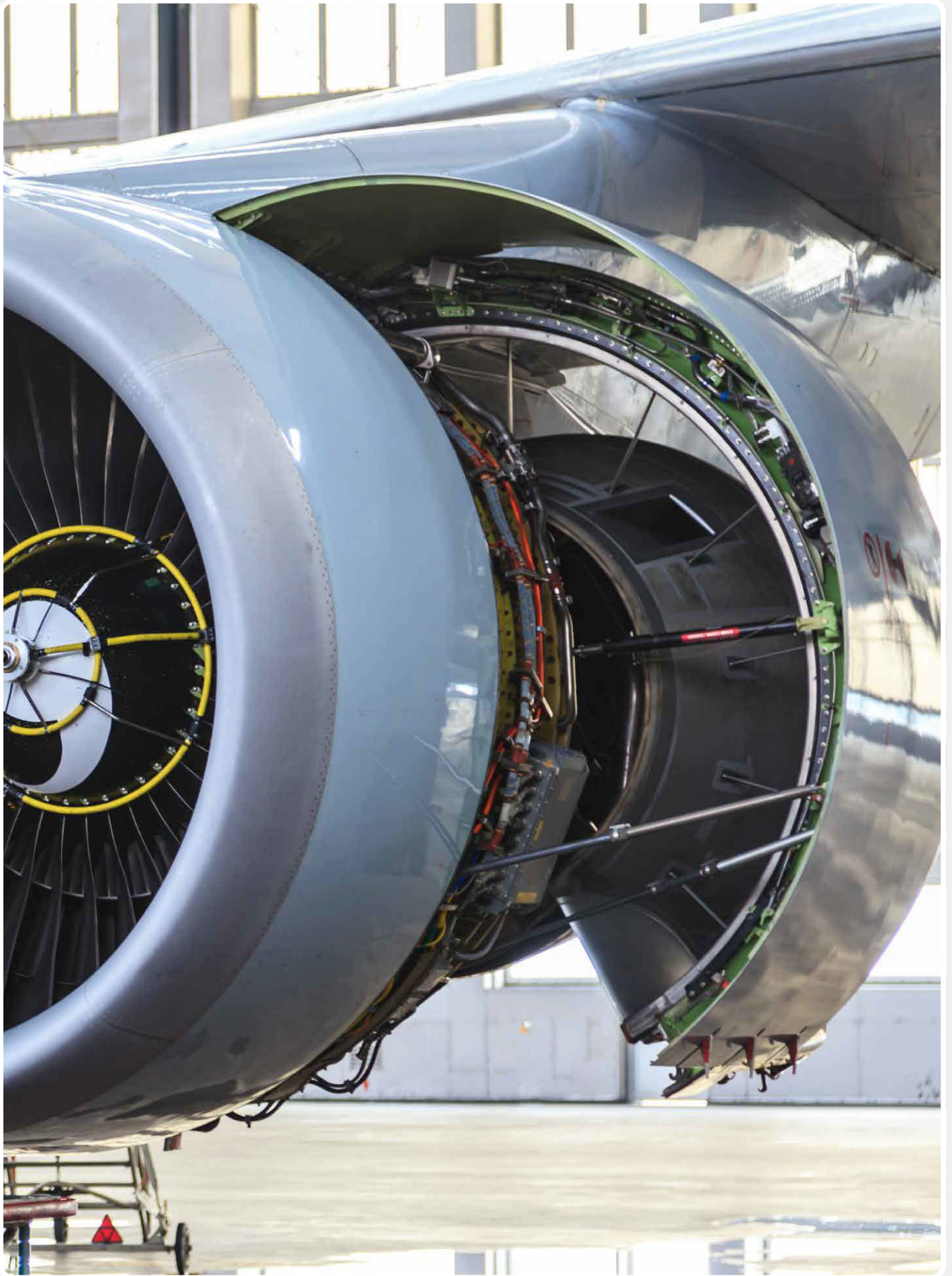

Zerspanen der spezifischen Materialien
Machining of specific materialsSeite 06-07

Aluminiumzerspanung
Aluminum machiningSeite 08-09

Titanzerspanung
Titanium machiningSeite 10-15

Stahlbearbeitung
Steel machiningSeite 16-21

Bearbeitung von Inconel
Machining of InconelSeite 22-27

PKD-Bearbeitung
PCD machiningSeite 28-29

Inhalt Katalog
Content CatalogueSeite 30-37

Katalog
Catalogue.....Seite 38-157



Die Luft- und Raumfahrtindustrie gewinnt in der Personen- und Frachtbeförderung immer größere Bedeutung. Seit vielen Jahren ist Ingersoll in diesem expandierenden Markt tätig.

In intensiver Zusammenarbeit mit unseren Kunden aus der Luft- und Raumfahrtindustrie entwickeln wir anwendungsorientierte Lösungen für die Bearbeitung von Triebwerksteilen, Aluminiumteilen und einer Vielzahl von weiteren Bauteilen. Für die unterschiedlichsten Werkstoffe und Bauteile konzipieren wir die optimalen Werkzeuglösungen mit den entsprechenden Schneidstoffen.



MACHINING OF SPECIFIC MATERIALS OF AIRCRAFT AND AEROSPACE



The aircraft and aerospace industry gains more and more importance in the area of passenger and freight transport. Ingersoll has been operating in this expanding market for many years.

In close cooperation with our customers in the aircraft and aerospace industry we develop solutions to suit the application for machining turbine parts, aluminum parts and much more. We develop and design optimum cutting tool solutions with adequate cutting materials for the most various materials and components.

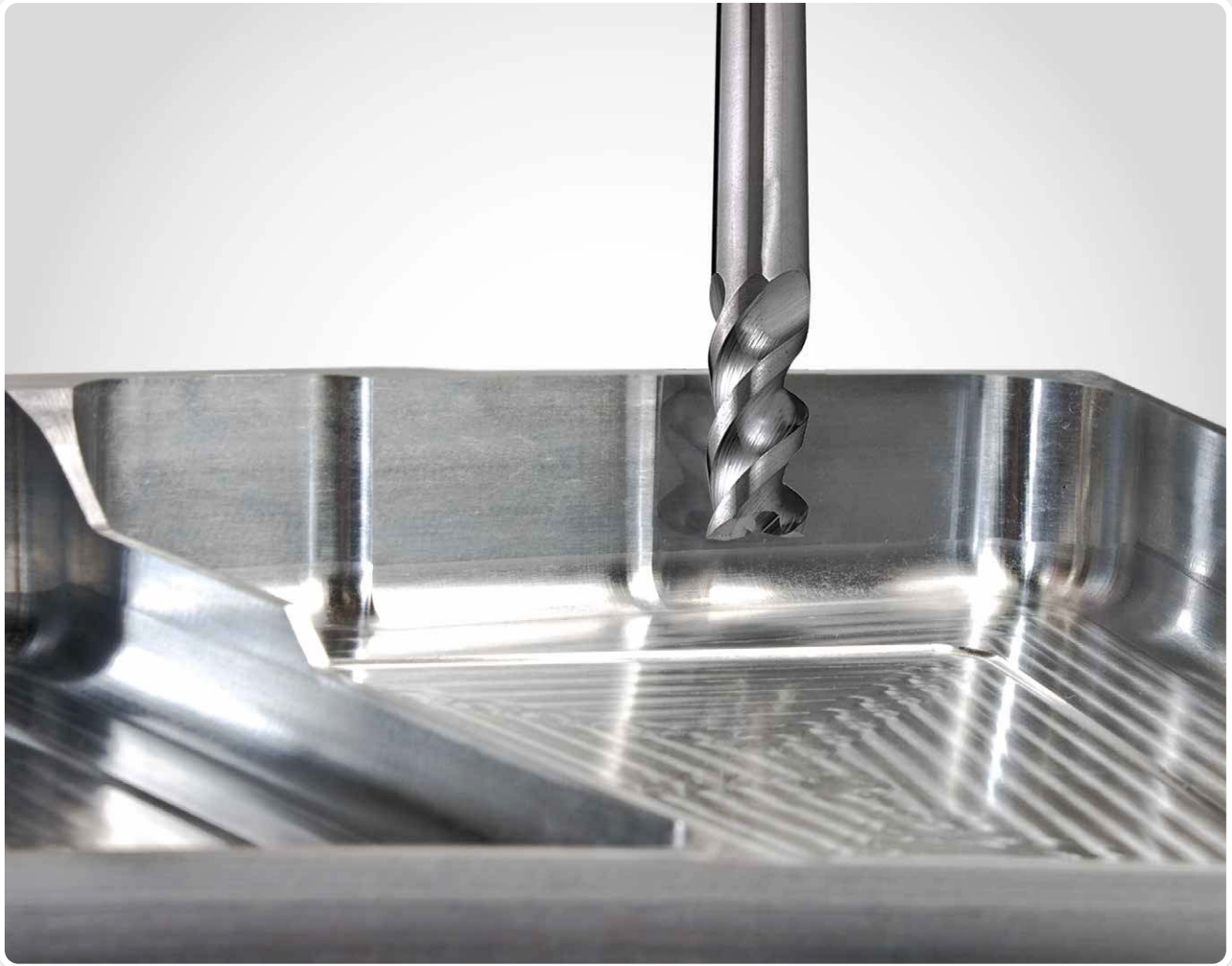

Im Bereich der Aluminiumzerspanung werden immer größere Zerspanvolumen gefordert, Spindeln mit mehr als 100 kW Leistung, Drehzahlen mit mehr als 30.000 U/min und Vorschubgeschwindigkeiten von mehr als 50 m/min erfordern auch immer leistungstärkere Werkzeuge. Bei Zerspanraten von bis zu 95% an Strukturbauteilen und Zeitspanvolumina von mehr als 10.000 cm³/min (entsprechend rund 27 kg/min) ist die Wahl des richtigen Bearbeitungswerkzeuges ein entscheidender Faktor, um die Kosten bei der Herstellung von Bauteilen der Luft- und Raumfahrtindustrie zu senken. Höchste Anforderungen an Schneidengeometrie und Hartmetall-Substrate sind daher entscheidend, um sich vom Wettbewerb abzuheben. Ingersoll bietet Ihnen diese Werkzeuge für die Schrupp- und Schlichtbearbeitung mit Wendeplatten- und Vollhartmetallfräsern.



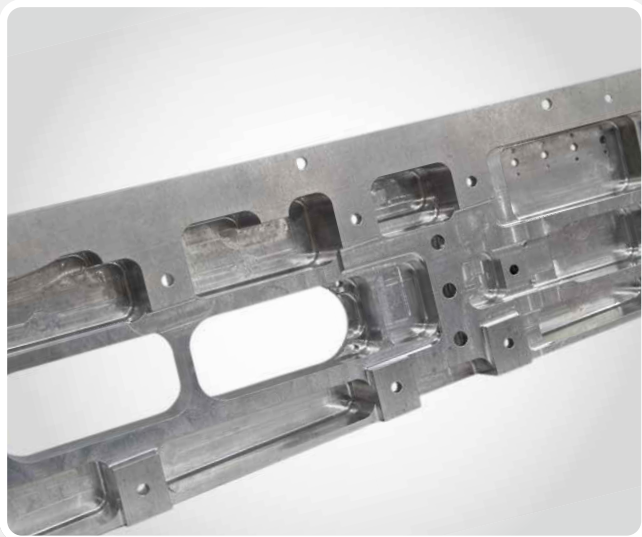

In the range of aluminum machining constantly growing chip removal rates are demanded. Machine tools with more than 100 kW power and feed rates higher than 50 m/min require high-performance tools. With chip removal rates of up to 95 % at structural components and chip removal rates higher than 10000 cm³/min (correspond up to approx. 27 kg/min) makes the right choice of machining tools an even more important factor to decrease the production costs of components of the aerospace industry. Highest demands on cutting edge geometries and solid carbide grades are therefore very crucial to stand out from the competition. Ingersoll provides you with the proper indexable and solid carbide milling cutters for rough and finish machining.



Im Bereich der Titanzerspanung werden Zerspanvolumen von über 1.000 cm³/min gefordert und vor einigen Jahren waren es gerade mal 150 cm³/min. Leistungsstärkere Maschinen sowie neue Werkzeug-geometrien zur HSC- und HPC-Zerspannung ermöglichen es nun, dieses extrem hohe Zerspanvolumen auch bei schwer zu zerspannenden Titanlegierungen zu realisieren. Schnittgeschwindigkeiten von bis zu 100 m/min sind keine Seltenheit mehr, Zahnvorschübe bis zu 1 mm pro Zahn können auch in diesen Materialien mit Hochvorschubfräsern realisiert werden. Ingersoll bietet Ihnen speziell abgestimmte Werkzeuggeometrien mit den dazugehörigen Wendeschneidplatten bzw. entsprechende Vollhartmetallfräser.



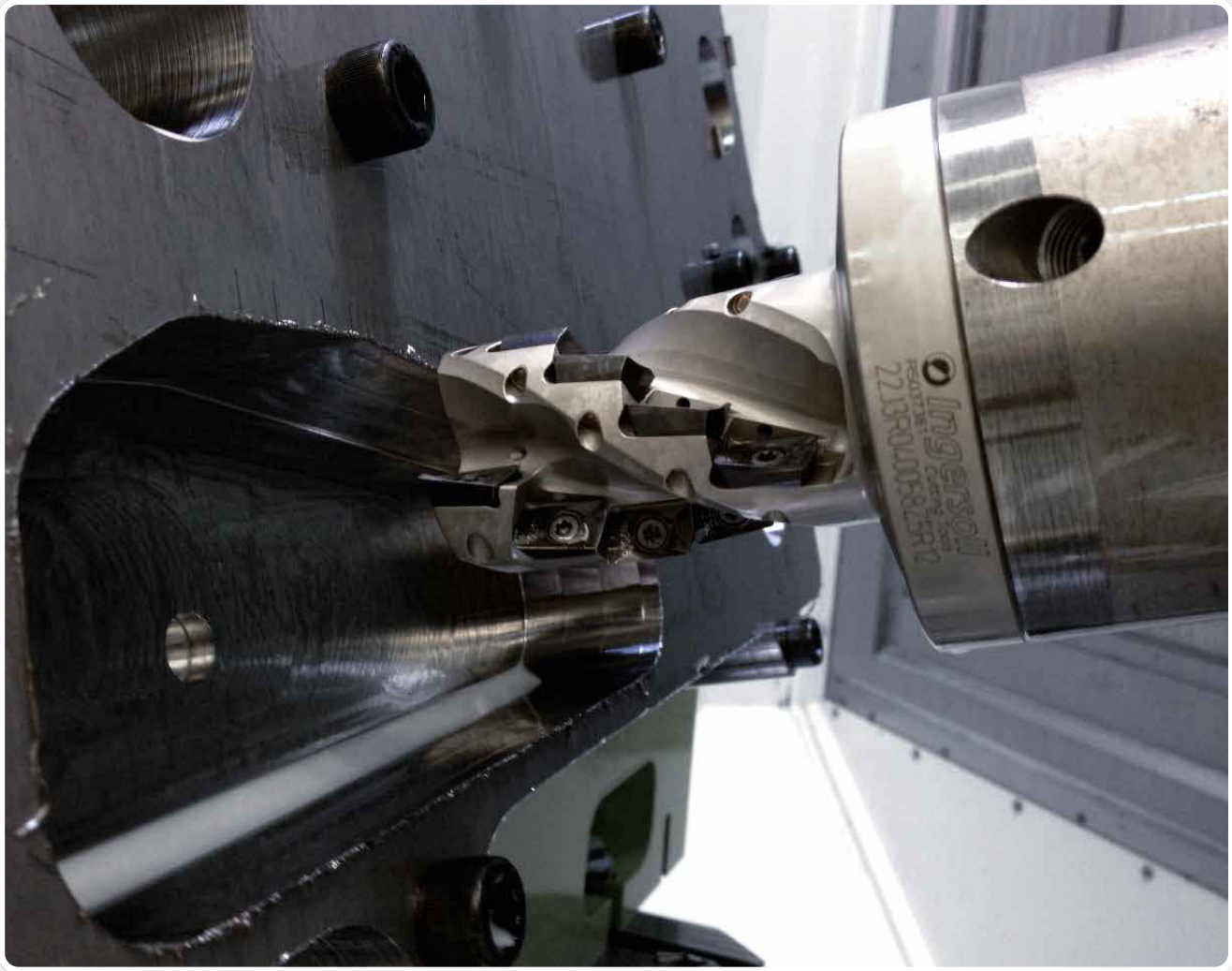

In the field of titanium machining chip removal rates of more than 1.000 cm³/min are required. Only some years ago just about 150 cm³/min was reached. Machines with higher power as well as new tool geometries for HSC and HPC machining make it now possible to realize these extremely high chip removal rates even for titanium alloys which are difficult to machine. Cutting speeds up to 100 m/min are not uncommon and feed rates up to 1 mm per tooth can be reached when machining these for this materials by means of high feed cutters. Ingersoll offers you specially adapted tool geometries with appropriate inserts as well as solid carbide cutters.

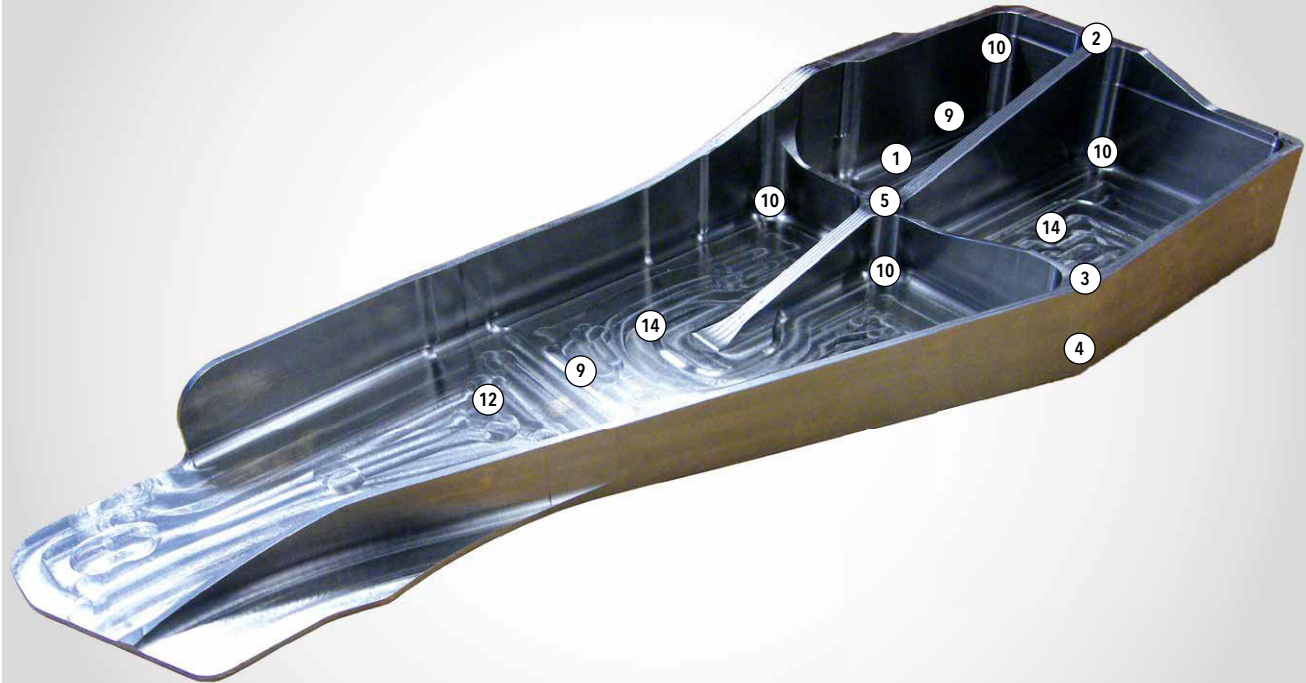

1
Startloch vollbohren
Start hole drilling



2
Stege (Oberkante) abwälzen
Hobbing walls (top edge)



3
Stege (Oberkante) fräsen
Milling walls (top edge)



4
Außenkontur abwälzen
Hobbing outside contour



5
Oberkanten innen vorfräsen
Roughing inside walls top edge



6
Oberkanten innen vorfräsen
Roughing inside walls top edge



7
Oberkanten schlichten
Finishing walls top edge

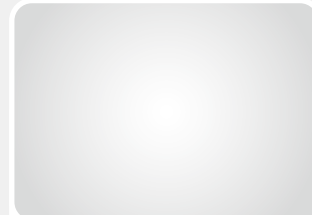

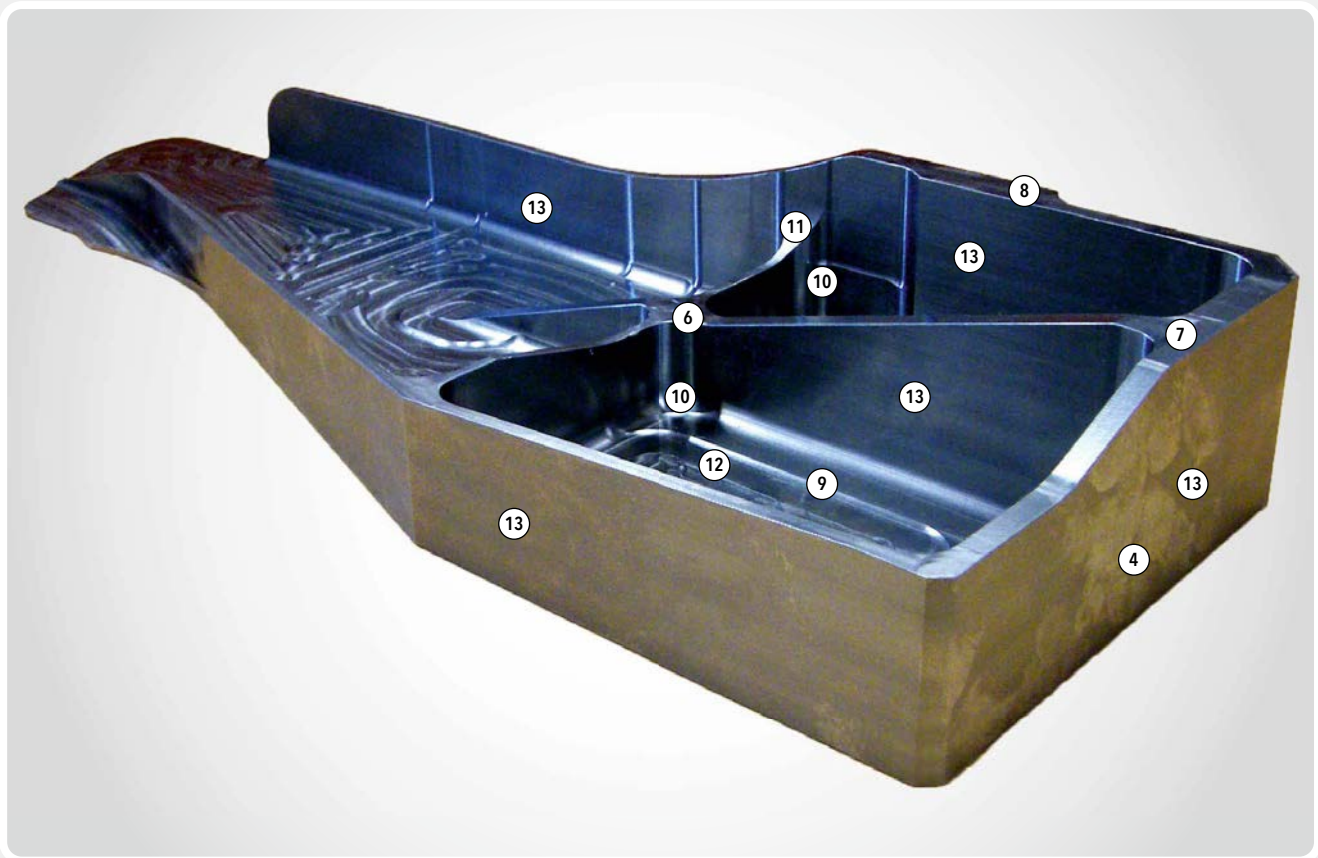

8
Oberkante schlichten
Finishing wall top edge

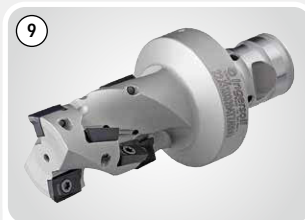

9
Taschen ausräumen
Broaching pockets



10
Taschen-Ecken freistechen
Plunging pocket corners



11
Oberkante-Radius schlichten
Finishing wall top radius



12
Böden vorschlichten
Semi-finishing bottom

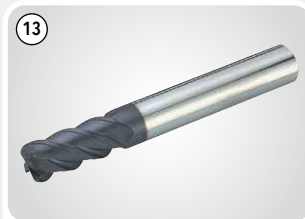

13
Konturen vorschlichten und schlichten
Semi-finishing and finishing contours

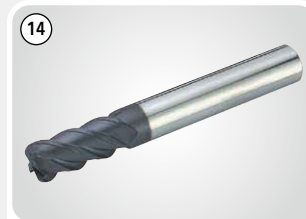

14
Böden schlichten
Finishing bottom

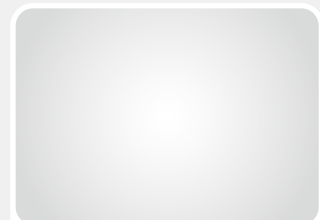

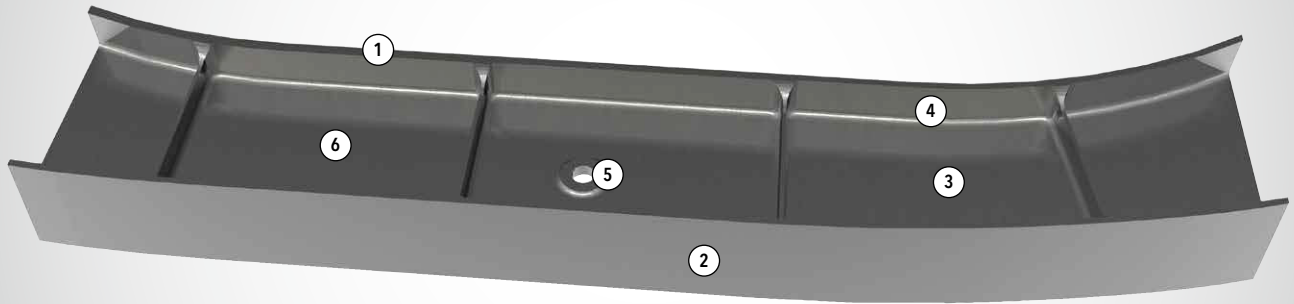

1
Stege (Oberkante) schrappen
 Roughing walls (top edge)



2
Außenkanten schrappen
 Roughing walls



3
Boden der Taschen schrappen
 Roughing bottom of the pockets



4
Wände der Taschen schrappen
 Roughing walls of the pockets



5
Bohren
 Boring



6
Taschen schlichten
 Finishing pockets

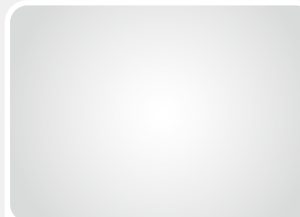
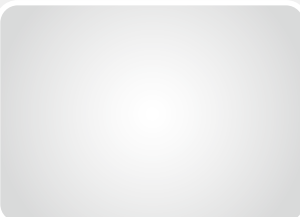
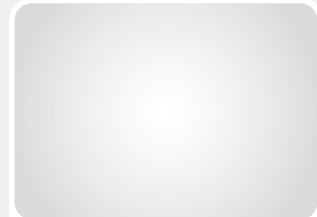
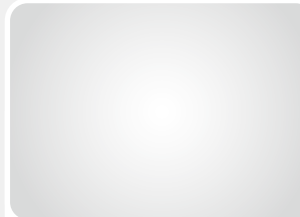

ANWENDUNGSBEISPIELE / APPLICATION EXAMPLES

Boden der Taschen schrappen / Roughing bottom of the pockets

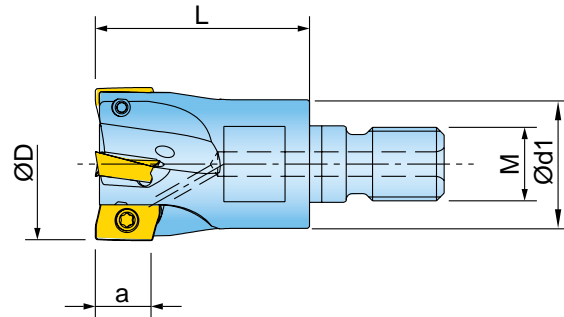

Schnittwerte / Cutting data

Vc:	50 m/min
fz:	0,12 mm
n:	636 U/min
Vf:	305 mm/min
ae:	23 mm
ap:	5 mm

Werkzeug und Wendschneidplatte / Tool and insert

ø [mm]:	25
Z:	4
Werkzeug / Tool:	12J1P025035X7R00
WSP / Insert:	BOMT130408
Qualität / Grade:	IN2005

Taschen schlichten / Finishing pockets

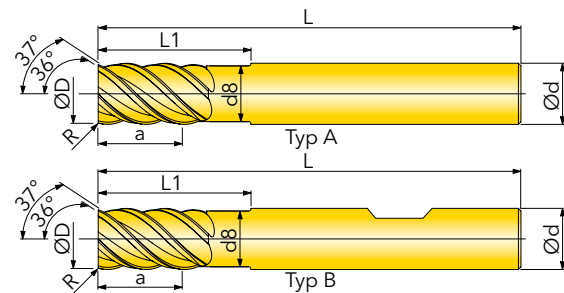

Schnittwerte / Cutting data

Vc:	70 m/min
fz:	0,08 mm
n:	1856 U/min
Vf:	742 mm/min
ae:	1 mm
ap:	26 mm

Werkzeug und Wendschneidplatte / Tool and insert

ø [mm]:	12
Z:	4
Werkzeug / Tool:	INN0T120.300.038Z4C
WSP / Insert:	-
Qualität / Grade:	IN2005



Fahrwerkssysteme in der Luftfahrtindustrie bestehen aus zähen, nichtrostenden und hochfesten Werkstoffen. Dies ist eine weitere Herausforderung für die Werkzeugsysteme. Auch hier ist Ingersoll führend in der Zerspanung dieser exotischen Materialien. Speziell beim Fräsen, Bohren und Drehen benötigt man eine präzise Wendeplattengeometrie, um ein wirtschaftliches und prozesssicheres Ergebnis zu bekommen. Ingersoll hat hier spezielle Schneidstoffe, die sowohl bei der Trocken- als auch Nassbearbeitung eingesetzt werden können.



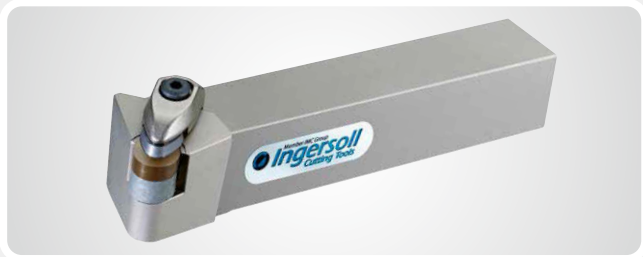

Landing gears in the aerospace industry are made of tough, stainless and high-strength materials. This is another challenge for our tooling systems. Here Ingersoll also leads the field in machining these exotic materials. Especially for milling, boring and turning operations precise insert geometries are required to achieve an economic and process-reliable solution. Ingersoll has the special cutting materials applicable for both dry and wet machining.



Hochgeschwindigkeits-Schruppen
High speed roughing



Radiales Aufmaß vorbereiten (Schruppen)
Roughing



Kopierdrehen (Schruppen)
Roughing



Innenkontur vorbereiten (Schruppen)
Roughing



Schlichten Innenkontur
Finishing



Feinbearbeitung (Schlichten)
Finishing



Axialkontur Feinbearbeitung (Schlichten)
Finishing



Gewindfreistich (Stechen)
Grooving



Gewinde
Threading



Nuten eintauchen
Plunging



Halter für Schritt 4 und 16
Tool holder for step 4 and 16



Halter für Schritt 7
Tool holder for step 7

TURBINE WHEEL / MATERIAL: C45



10
Nuten vorfräsen
Roughing



11
Nuten schlichten
Finishing



12
Radiales Aufmaß vorbereiten
(Schruppen)
Roughing



13
Innenkontur vorbereiten (Schruppen)
Roughing



14
Axialkontur vorbereiten (Schruppen)
Roughing



15
Stechdrehen Innenkontur (Schruppen)
Roughing



16
Schlichten Innenkontur
Finishing



17
Einstecken Sicherungsnut
Grooving



18
Rückseitenfeinbearbeitung (Schlichten)
Finishing



19
Nuten trochoidal vorfräsen (Schruppen)
Roughing



20
Nuten schlichten
Finishing



21
Halter für Schritt 6, 14 und 18
Tool holder for step 6, 14 and 18

ANWENDUNGSBEISPIELE

Hochgeschwindigkeits-Schruppen / High speed roughing



Schnittwerte / Cutting data

Vc:	250 m/min
fz:	0,2 mm
n:	-
Vf:	-
ae:	-
ap:	2-4 mm

Werkzeug und Wendeschneidplatte / Tool and insert

ø [mm]:	-
Z:	-
Werkzeug / Tool:	TRGNR 2525 M1207-F
WSP / Insert:	RNGN 120700 T6
Qualität / Grade:	Whisker Keramik TC430

Schruppen Restmaterial Schultern / Roughing shoulders

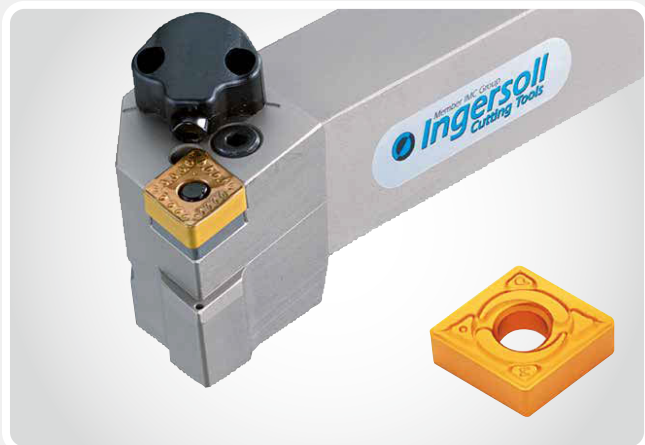

Schnittwerte / Cutting data

Vc:	60 m/min
fz:	0,25 mm
n:	-
Vf:	-
ae:	-
ap:	2,5 mm

Werkzeug und Wendeschneidplatte / Tool and insert

ø [mm]:	-
Z:	-
Werkzeug / Tool:	PCLNR 2525-M12-TB
WSP / Insert:	CNMG 120408 MP
Qualität / Grade:	TT5080

APPLICATION EXAMPLES

Seitliches Stechdrehen radial & axial in 3 Achsen / Concurrent turn groove operation in 3 axes

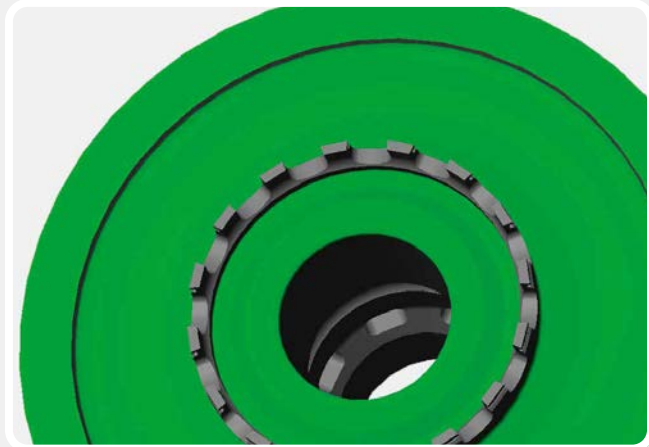

Schnittwerte / Cutting data

Vc:	320 m/min
fz:	0,3 mm
n:	U/min
Vf:	mm/min
ae:	mm
ap:	0,5 mm

Werkzeug und Wendschneidplatte / Tool and insert

ø [mm]:	-
Z:	-
Werkzeug / Tool:	C6-TCHPN / TCFL5T20-120-180 RN
WSP / Insert:	TDT 5E-2,5 RU
Qualität / Grade:	TT9080

Gewinde / Threading

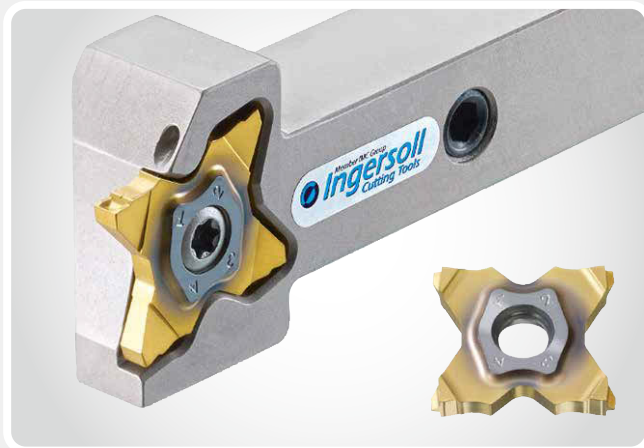

Schnittwerte / Cutting data

Vc:	180 m/min
fz:	1,5 mm
n:	U/min
Vf:	mm/min
ae:	mm
ap:	0,3 mm

Werkzeug und Wendschneidplatte / Tool and insert

ø [mm]:	-
Z:	-
Werkzeug / Tool:	TOHR 25-27-TB
WSP / Insert:	TQS 27-1.5-ISO
Qualität / Grade:	TT9080



Inconel ist der Handelsname für eine Reihe von nickelbasierenden Stahllegierungen, die rost- und korrosionsfrei sind. Nickel ist ein bedeutendes Legierungsmetall, das hauptsächlich zur Stahlveredelung verwendet wird. Der größte Teil des Nickels geht dorthin. Es macht Stahl korrosionsbeständig und erhöht seine Härte, Zähigkeit und Duktilität. Mit Nickel hochlegierte Stähle werden bei besonders korrosiven Umgebungen eingesetzt.

Der Edelstahl V2A enthält 8 % Nickel neben 18 % Chrom, V4A (Markennamen Cromargan oder Nirosta) 11 % neben 18 % Chrom und 2 % Molybdän. Nickel-Basis Superlegierungen sind Legierungen speziell für den Einsatz bei hohen Temperaturen und unter korrosiven Medien. Sie finden zum Beispiel in Flugzeugturbinen Anwendung



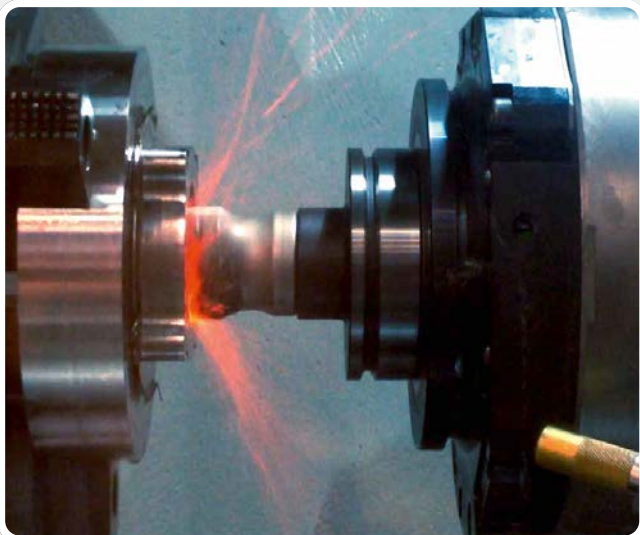
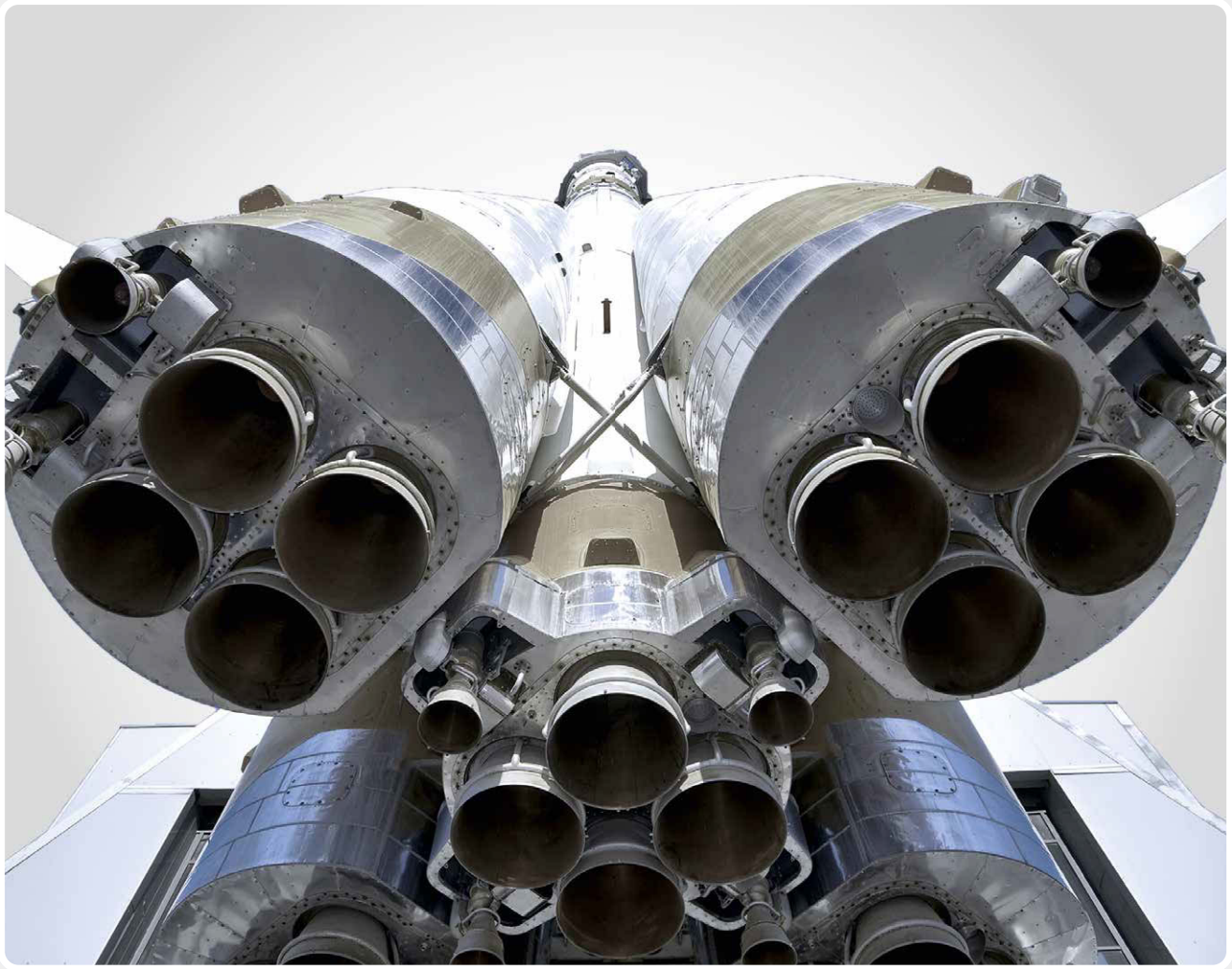

Inconel is the trade name for a series of nickel-based steel alloys, which are free of rust and corrosion. Nickel is an important alloy, used mainly to the steel finishing. It makes the steel resistant to corrosion and increases its hardness, toughness and ductility. High-alloy nickel steels are used in particularly corrosive environments.

The stainless steel V2A contains 8% nickel in addition to 18% chromium and V4A (brand name Cromargan or Nirosta) 11% nickel besides 18% chrome and 2% molybdenum. Nickel-based super alloys are used at high temperatures and corrosive media like aircraft turbines

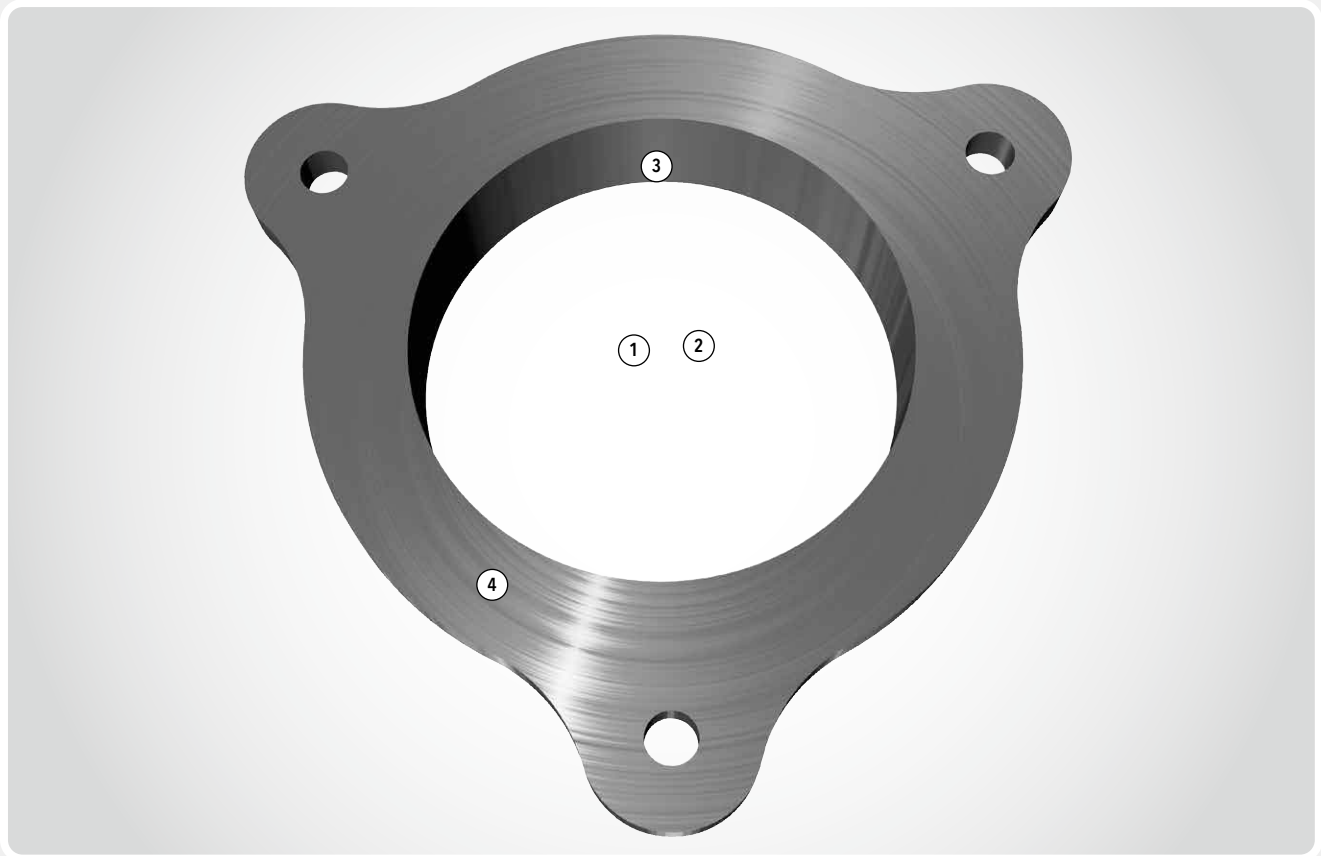

Vollbohren
Drilling

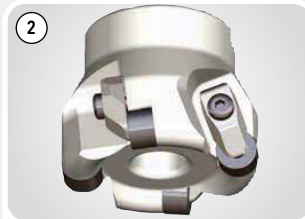

Bohrzirkularfräsen bis zu 60mm
Circular bore milling up to 60mm



Inneres Bohrloch schlichten
Finishing internal bore hole



Hochgeschwindigkeits-Planfräsen
High feed face milling



CONNECTING FLANGE

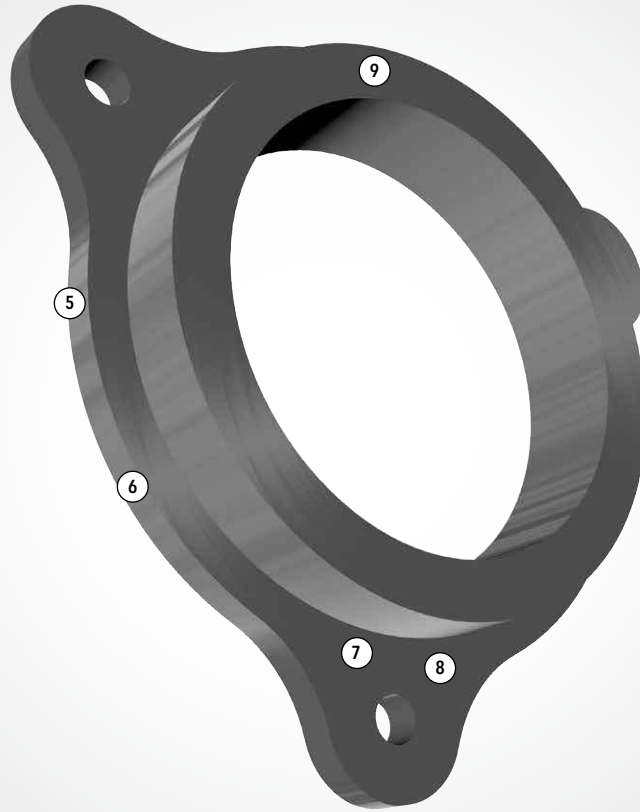

Hochgeschwindigkeitsfräsen (Kontur)
High speed milling (contour)



Kontur schlichten
Finishing contour

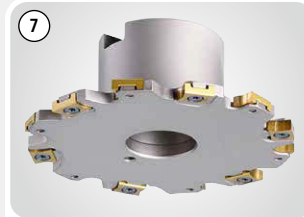

Fräsen des Unterschnitts
Milling undercut

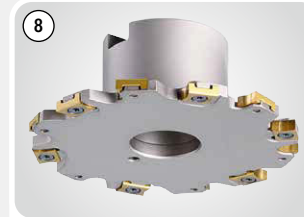

Schlichten des Unterschnitts
Finishing undercut



Seitliches Trenn-Fräsen
Cut off side milling

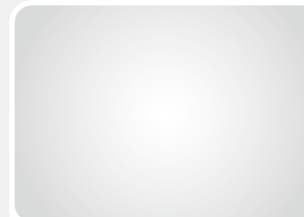
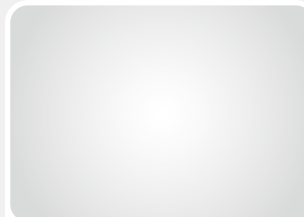
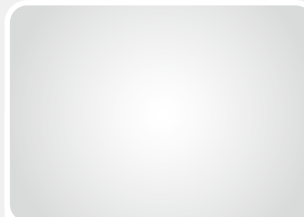
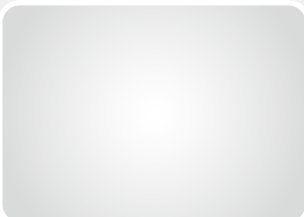
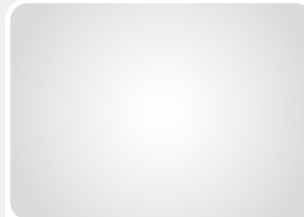
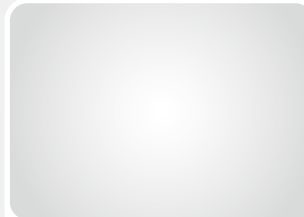

Inneres Bohrloch schlichten / Finishing internal borehole

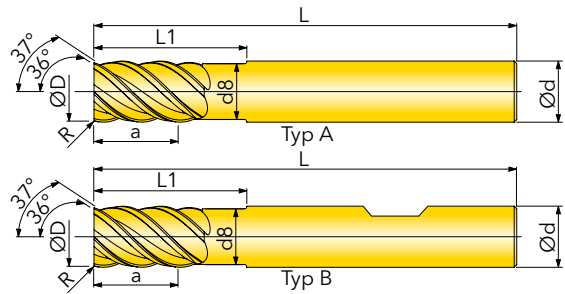

Schnittwerte / Cutting data

Vc:	100 m/min
fz:	0,1 mm
n:	1990 U/min
Vf:	1000 mm/min
ae:	0,5 mm
ap:	20 mm

Werkzeug und Wendeschneidplatte / Tool and insert

ø [mm]:	16
Z:	5
Werkzeug / Tool:	INNOT160.020.050Z5W
WSP / Insert:	-
Qualität / Grade:	IN2005

Hochgeschwindigkeits-Planfräsen / High speed face milling

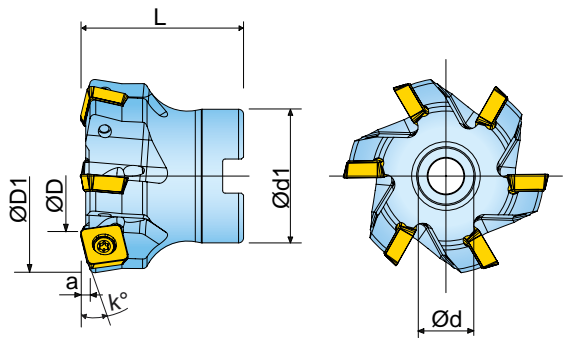

Schnittwerte / Cutting data

Vc:	60 m/min
fz:	0,7 mm
n:	239 U/min
Vf:	1340 mm/min
ae:	28 mm
ap:	1 mm

Werkzeug und Wendeschneidplatte / Tool and insert

ø [mm]:	80
Z:	8
Werkzeug / Tool:	5M5P080R00
WSP / Insert:	SDMS1305MDR-PH
Qualität / Grade:	IN4035

APPLICATION EXAMPLES

Hochgeschwindigkeitsfräsen (Kontur) / High speed milling (contour)

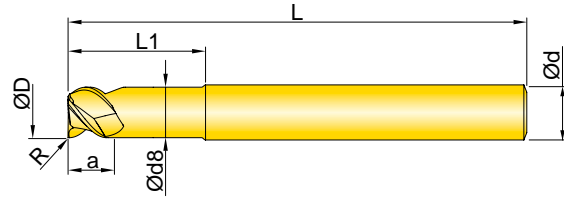

Schnittwerte / Cutting data

Vc:	675 m/min
fz:	0,2 mm
n:	13440 U/min
Vf:	8060 mm/min
ae:	16 mm
ap:	0,5 mm

Werkzeug und Wendschneidplatte / Tool and insert

ø [mm]:	16
Z:	3
Werkzeug / Tool:	INCER160.190.035Z3
WSP / Insert:	-
Qualität / Grade:	IN75N

Seitliches Trenn-Fräsen / Cut off side milling

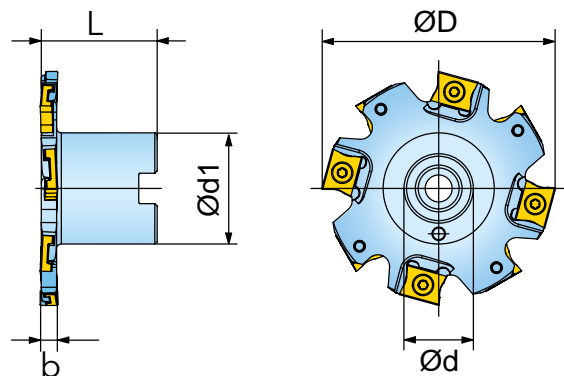

Schnittwerte / Cutting data

Vc:	60 m/min
fz:	0,1 mm
n:	150 U/min
Vf:	110 mm/min
ae:	10 mm
ap:	4 mm

Werkzeug und Wendschneidplatte / Tool and insert

ø [mm]:	125
Z:	7
Werkzeug / Tool:	3VJ5V125004F3R00
WSP / Insert:	IEE311-001
Qualität / Grade:	IN2530

















Die Aluminium-Frames zum Beispiel werden mit unseren leistungsfähigen Rough-Air Systemen bearbeitet, wobei mit den polierten Wendeschneidplatten Zustelltiefen bis zu 20 mm realisiert werden. Für die unterschiedlichen neueren Werkstoffe in der Luft- und Raumfahrt, wie glasfaserverstärkte Kunststoffe (GFK) oder Kohlefaserverbundstoffe (CFK), können sowohl unsere Schafffräser mit PKD-Bestückung verwendet werden, als auch für geringere Schnitttiefen die absolut flexiblen Chip-Surfer, welche auch als PKD-bestückte Werkzeuge erhältlich sind. Größere Werkzeugdurchmesser können auch hier mit PKD-bestückten Wendeschneidplatten eingesetzt werden, um den Vorteil von superharten Schneidstoffen zu nutzen. Um diese Konturen, Platten und Platinen bearbeiten zu können, bietet ein PKD-bestücktes Werkzeug mit dem härtesten Schneidstoff eine hervorragende Möglichkeit, die Fasern innerhalb des Glas-Harzverbundes zu schneiden. Durch spezielle Werkzeuggeometrien wird die Temperatur niedrig gehalten, da bei geringster Temperaturentwicklung die Faseranteile aus dem Harz gelöst werden und die sogenannte „Delamination“ eintritt.



















Aluminum frames, for example, are machined with our highperformance rough air systems, whereby the polished, indexable inserts can achieve infeed depths of up to 20 mm. For the various newer materials in the aircraft and aerospace industry such as glass fiber reinforced plastics (GRP) or carbon fiber reinforced composites (CFRP), both our braced PCD end mills and, for smaller depths of cut, our absolutely flexible Chip-Surfers, which are also available as PCD tools, can be used. Larger diameter tools equipped with PCD-tipped, indexable inserts can also be used to take advantage of the benefits of ultra-hard cutting materials. To be able to machine these contours, plates and boards, a PCD tool of the hardest cutting material provides an excellent means of cutting the fibers within the glass/resin composite. Thanks to special tool geometries, the temperature is kept low, as even small increases in temperature cause the fibers to separate from the resin, resulting in so-called "delamination".

FRÄSER / MILLING CUTTERS

	D	a/b	Beschreibung / Description	Serie / Code	Seite / Page
	25 - 40	8,4	ALUMINATOR™ Schafffräser 15U1G...X End mill 15U1G...X	15U1G...X	38
	50 - 100	8,4	ALUMINATOR™ Eckfräser 5H6G Shoulder-type face mill 5H6G	5H6G	39
	20 - 42	15,5	ROUGHAIR™ Schafffräser 15X1W...X End mill 15X1W...X	15X1W...X	40
	50 - 80	15,5	ROUGHAIR™ Eckfräser 5X6W Shoulder-type face mill 5X6W	5X6W	41
	32 - 80	15,5	ROUGHAIR™ Schafffräser 15X1W...H5 End mill 15X1W...H5	15X1W...H5	42-43
	32 - 80	15,5	ROUGHAIR™ Schafffräser 15X1W...H7 End mill 15X1W...H7	15X1W...H7	44-45
	32 - 80	15,5	ROUGHAIR™ Schafffräser 15X1W...H9 End mill 15X1W...H9	15X1W...H9	46-47
	25 - 40	16	HIPOSOALU™ Schafffräser 1AX2K...X End mill 1AX2K...X	1AX2K...X	48-49
	40 - 125	16	HIPOSOALU™ Eckfräser AX2K Shoulder-type face mill AX2K	AX2K	50-51
	25 - 42	21	ROUGHAIR™ Schafffräser 15X1X...X End mill 15X1X...X	15X1X...X	52
	50 - 125	21	ROUGHAIR™ Eckfräser 5X6X Shoulder-type face mill 5X6X	5X6X	53
	50	25,5	ROUGHAIR™ Schafffräser 15X1Z...H End mill 15X1Z...H	15X1Z...H	54
	63 - 100	66,2 - 103	GOLDQUAD™ Walzenstirnfräser 25J3P...F Extended flute end mill 25J3P...F	25J3P...F	55
	50 - 160	11,3	GOLDQUAD™ Eckfräser 5J5P Shoulder-type face mill 5J5P	5J5P	56















Druckfehler, Irrtümer und technische Änderungen vorbehalten. / Subject to printing error or technical changes.

FRÄSER / MILLING CUTTERS

	D	a/b	Beschreibung / Description	Serie / Code	Seite / Page
	37,8 - 72,8	1,5	GOLDQUAD^{FF} Hochvorschubfräser 5G_F High feed cutter 5G_F	5G_F	57
	12,9 - 29,8	1,5	GOLDQUAD^{FF} Hochvorschubfräser 15G1F...X High feed cutter 15G1F...X	15G1F...X	58-59
	11 - 21	2	GOLDQUAD^{FF} Hochvorschubfräser 15M1P...X High feed cutter 15M1P...X	15M1P...X	60-61
	29 - 79	2	GOLDQUAD^{FF} Hochvorschubfräser 5M_P High feed cutter 5M_P	5M_P	62-63
	48,6 - 128,6	3	GOLDQUAD^{FF} Hochvorschubfräser 5G_M High feed cutter 5G_M	5G_M	64
	20,1 - 22,1	4,9	GOLDQUAD^{XXXX} Planfräser 30° 15M1P...X Face mill 30° 15M1P...X	15M1P...X	65
	30,1 - 80,1	4,9	GOLDQUAD^{XXXX} Planfräser 30° 5M_P Face mill 30° 5M_P	5M_P	66
	51,7 - 131,7	7,8	GOLDQUAD^{XXXX} Planfräser 30° 5G5M Face mill 30° 5G5M	5G5M	67
	16 - 42	1	HI-FEED^{MIMI} Hochvorschubfräser 1TG1F...X High feed cutter 1TG1F...X	1TG1F...X	68-69
	32 - 63	46 - 81	HI-POS^{TS} Walzenstirnfräser 22J3R...Z (TITAN) Extended flute end mill 22J3R...Z (TITAN)	22J3R...Z (TITAN)	70-71
	32 - 80	46,5 - 80,5	HI-POS^{TS} Walzenstirnfräser 22J3X...Z Extended flute end mill 22J3X...Z	22J3X...Z	72
	40 - 80	12	HI-POS^{TS} Eckfräser 2J1X Shoulder-type face mill 2J1X	2J1X	73
	80 - 315	9	HIPOSQUADTM Planfräser 5N6R Face mill 5N6R	5N6R	74-75
	63 - 160		GOLD-SLOTTM Scheibenfräser 3VJ5V..F Schnittbreite 3-6 mm Slot mill 3VJ5V..F 3-6 mm cutting width	3VJ5V..F Schnittbreite 3-6 mm 3VJ5V..F 3-6 mm cutting width	76-77















Druckfehler, Irrtümer und technische Änderungen vorbehalten. / Subject to printing error or technical changes.

FRÄSER / MILLING CUTTERS

	D	a/b	Beschreibung / Description	Serie / Code	Seite / Page
	63 - 160		GOLDOSLOT™ Scheibenfräser 3VJ5V..F Schnittbreite 7-10 mm Slot mill 3VJ5V..F 7-10 mm cutting width	3VJ5V..F Schnittbreite 7-10 mm 3VJ5V..F 7-10 mm cutting width	78-79
	24 - 42	6	FORMMASTER™ Kopierfräser 15B1H...X Copy end mill 15B1H...X	15B1H...X	80
	50 - 160	8	FORMMASTER^{PRO}™ Kopierfräser 5E6K Copy face mill 5E6K	5E6K	81
	50 - 160		GOLDQUAD^{PLUNGE}™ Tauchfräser QHU...F/E Plunging mill QHU...F/E	QHU...F/E	82
	8 - 20	12 - 30	INNOVATIVEalu™ Kordelverzahnte Schruppfräser Z=3 Serrated roughing end mill Z=3	Z=3	83
	8 - 20	12 - 30	INNOVATIVEalu™ HPC Fräser Z=3 (ALU) HPC end mill Z=3 (ALU)	Z=3 (ALU)	84
	8 - 20	12 - 30	INNOVATIVEalu™ HPC Fräser Z=4 (ALU) HPC end mill Z=4 (ALU)	Z=4 (ALU)	85
	5 - 25	13 - 50	INNOTitan™ HPC Titan-Fräser Z=4 HPC titanium end mill Z=4	Z=4	86-87
	6 - 20	13 - 42	INNOTitan™ HPC Titan-Fräser Z=5 HPC titanium end mill Z=5	Z=5	88
	12 - 25	46 - 80	INNOTitan™ HPC Titan-Fräser Z=5 3xD HPC titanium end mill Z=5 3xD	Mill Z=5 3xD	89
	6 - 20	6 - 15	INCERamic™ Vollkeramik Speedfräser Z=3 Solid ceramic speed end mill z=3	mill z=3	90
	4 - 16	4 - 12	INCOOLant™ Speed-Fräser Z=3 High-speed end mill, z=3	z=3	91
	8 - 25	5 - 22	CHIP SURFER™ HPC für Titan / Inconel HPC for Titanium / Inconel	Titanium / Inconel	92
	8 - 25	5 - 22	CHIP SURFER™ HPC Schrupp- / Schlichtgeometrie Z=4 TITAN / Rostfreier Stahl / HPC roughing / finishing geometry Z=4 TITAN / stainless steel	Rostfreier Stahl HPC Roughing / finishing geometry Z=4 TITAN / stainless steel	93















Druckfehler, Irrtümer und technische Änderungen vorbehalten. / Subject to printing error or technical changes.

FRÄSER / MILLING CUTTERS

	D	a/b	Beschreibung / Description	Serie / Code	Seite / Page
	8 - 25	5 - 22	CHIPOSURFER™ HPC Schrupp-/ Schlichtgeometrie Z=5 TITAN / Rostfreier Stahl / HPC roughing / finishing geometry Z=5 TITAN / stainless steel	Rostfreier Stahl HPC roughing / finishing geometry Z=5 TITAN / stainless steel	94
	8 - 20	5,5 - 12,7	CHIPOSURFER™ Schruppfräser NE-Geometrie Roughing cutter for aluminum	Aluminium Aluminum	95
	8 - 20	5 - 12	CHIPOSURFER™ Schafffräser mit Eckradius NE-Geometrie Z=3 End mill with corner radius for aluminum Z=3	mit Eckradius NE-Geometrie Z=3 with corner radius for Aluminum Z=3	96
	8 - 20	10 - 23	CHIPOSURFER™ Schafffräser mit PKD Bestückung End mill with PCD tips	PCD tips	97
	8 - 20	5 - 14	CHIPOSURFER™ Kugelfräser mit PKD Bestückung Ball nose cutter with PCD tips	with PCD tips	98
	14,0 - 26,0		QUADOTWIST™ WSP-Vollbohrer 2D Ø14 - Ø26 Indexable drill 2D Ø14 - Ø26	2D Ø14 - Ø26	100-101
	27,0 - 50,0		QUADOTWIST™ WSP-Vollbohrer 2D Ø27 - Ø50 Indexable drill 2D Ø27 - Ø50	2D Ø27 - Ø50	102-103
	14,0 - 26,0		QUADOTWIST™ WSP-Vollbohrer 3D Ø14 - Ø26 Indexable drill 3D Ø14 - Ø26	3D Ø14 - Ø26	104-105
	26,5 - 50,5		QUADOTWIST™ WSP-Vollbohrer 3D Ø26,5 - Ø50,5 Indexable drill 3D Ø26,5 - Ø50,5	3D Ø26,5 - Ø50,5	106-107
	14,0 - 26,0		QUADOTWIST™ WSP-Vollbohrer 4D Ø14 - Ø26 Indexable drill 4D Ø14 - Ø26	4D Ø14 - Ø26	108-109
	27,0 - 50,0		QUADOTWIST™ WSP-Vollbohrer 4D Ø27 - Ø50 Indexable drill 4D Ø27 - Ø50	4D Ø27 - Ø50	110-111
	14,0 - 26,0		QUADOTWIST™ WSP-Vollbohrer 5D Ø14 - Ø26 Indexable drill 5D Ø14 - Ø26	5D Ø14 - Ø26	112-113
	27,0 - 50,0		QUADOTWIST™ WSP-Vollbohrer 5D Ø27 - Ø50 Indexable drill 5D Ø27 - Ø50	5D Ø27 - Ø50	114-115
			GOLDOTWIST™ Wechselkopf-Vollbohrer 1,5D Ø6,0-Ø25,9 Head changeable drill 1,5D Ø6,0-Ø25,9	Ø6,0-Ø25,9	116























Druckfehler, Irrtümer und technische Änderungen vorbehalten. / Subject to printing error or technical changes.

DREHEN & STECHEN / TURNING & PARTING

	Bezeichnung / Designation	Beschreibung / Description	Seite / Page
	RHINO TURN CNGG 0904_ML	Negative 80° Wendeschneidplatte umfangsgeschliffen, für leichte bis mittlere Bearbeitung / sehr scharf Negative 80° rhombic ground inserts, for medium light machining / very sharp	136
	TOTURN CNGG ML	Negative 80° Wendeschneidplatte umfangsgeschliffen, für leichte bis mittlere Bearbeitung / sehr scharf Negative 80° rhombic ground inserts, for medium light machining / very sharp	136
	TOTURN CNMG ML	Negative 80° Wendeschneidplatte, für leichte bis mittlere Bearbeitung / sehr scharf Negative 80° rhombic insert, for medium light machining / very sharp	137
	TOTURN CNMG MP	Negative 80° Wendeschneidplatte, für mittlere Bearbeitung / positiver Spanwinkel Negative 80° rhombic insert, for medium machining / positive rake angle	138
	RHINO TURN DNGG 1305_ML	Negative 55° Wendeschneidplatte, zur mittleren Bearbeitung / sehr scharf / umfangsgeschliffen Negative 55° rhombic ground inserts, for medium light machining / very sharp	139
	TOTURN DNGG ML	Negative 55° Wendeschneidplatte, zur mittleren Bearbeitung / sehr scharf / umfangsgeschliffen Negative 55° rhombic ground inserts, for medium light machining / very sharp	139
	TOTURN DNMG ML	Negative 55° Wendeschneidplatte, für leichte bis mittlere Bearbeitung / sehr scharf Negative 55° rhombic inserts, for medium light machining / very sharp	140
	TOTURN DNMG MP	Negative 55° Wendeschneidplatte, zur mittleren Bearbeitung / positiver Spanwinkel Negative 55° rhombic inserts, for medium machining / positive rake angle	140
	TOTURN SNMG MP	Negative 90° Wendeschneidplatte, zur mittleren Bearbeitung / positiver Spanwinkel Negative 90° square inserts, for medium machining / positive rake angle	141
	RHINO TURN TNMG 1304_MK	Negative 60° Wendeschneidplatte, zur mittleren Bearbeitung von rostfreien und hitzebeständigen Materialien. Negative 60° triangular inserts, for stainless steel and heat resistant material	141
	TOTURN TNMG ML	Negative 60° Wendeschneidplatte, für leichte bis mittlere Bearbeitung / sehr scharf Negative 60° triangular inserts, for medium light machining / very sharp	142
	TOTURN VNGG ML	Negative 35° Wendeschneidplatte, zum mittleren Schruppen Common type chipbreaker, negative 35° rhombic inserts, for medium roughing	142
	TOTURN WNMG MP	Negative 80° Trigon-Wendeschneidplatte, zur mittleren Bearbeitung / positiver Spanwinkel, Chipbreaker, negative 80° trigon inserts, for medium machining / positive rake angle	143
	TOTURN CCGT FL	Positive 80° Wendeschneidplatte mit 7° Freiwinkel, für Aluminium mit polierter Spanfläche Chipbreaker, positive 7° clearance 80° rhombic inserts, for aluminum machining	144

Druckfehler, Irrtümer und technische Änderungen vorbehalten. / Subject to printing error or technical changes.

DREHEN & STECHEN / TURNING & PARTING

	Bezeichnung / Designation	Beschreibung / Description	Seite / Page
	TOTURN™ DCGT FL	Positive 55° Wendeschneidplatte mit 7° Freiwinkel, für Aluminium mit polierter Spanfläche Chipbreaker, positive 7° clearance 55° rhombic inserts, for aluminum machining	144
	TOTURN™ DCGT SA	Positive 55° Wendeschneidplatte mit 7° Freiwinkel (umfanggeschliffen), zur Schlichtbearbeitung Positive 55° Insert - 7° clearance (peripheral ground), for finishing	145
	TOTURN™ VBGT SA	Positive 35° Wendeschneidplatte mit 5° Freiwinkel (umfanggeschliffen), zur Schlichtbearbeitung Positive 35° Insert - 5° clearance (peripheral ground), for finishing	145
	TOBURST™ PCLNR/L-TB	 CN_	146
	TOBURST™ PDJNR/L-TB	 DN_	146
	TOBURST™ PWLNR/L-TB	 WN_	147
	TOBURST™ SRGCR/L-TB	 RC_	147
	TOBURST™ SVJBR/L-TB	 VB_	148
	COMBI CLAMP™ TRG NR/L-F	 RN_N_	148
	RHINO TURN™ A-SCLNR/L 0904	 CN_	149
	RHINO TURN™ A-HDUNR/L 1305	 DN_	149
	TOCLAMP™ ULTRA+™ TDJ	Zweiseitige Schneideinsätze zum Ab- und Einstechen, mit "J"-Typ Spanformer Double ended inserts, with "J" type chipbreaker for parting and grooving	150
	TOCLAMP™ ULTRA+™ TDC	Zweiseitige Schneideinsätze zum Ab- und Einstechen, mit "C"-Typ Spanformer Double ended inserts, with "C" type chipbreaker for parting and grooving	151
	GOLD FLEX™ TQS 27	4-Schneidige Stechwendeschneidplatte, zum Präzisionseinstechen mit positivem Spanwinkel 4-cutting edge insert, for precision grooving, straight cutting edges with high positive rake angle	152

Druckfehler, Irrtümer und technische Änderungen vorbehalten. / Subject to printing error or technical changes.

MIT EINSCHRAUBANSCHLUSS
 SCREW-IN TYPE ADAPTION

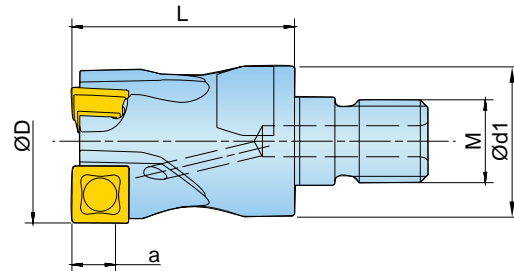

Artikel-Nr. Designation	D	d1	L	a	M	Z			
15U1G025035X7R00	25	21	35	8,4	M12	2	7,0	✓	0,08
15U1G032043X8R00	32	29	43	8,4	M16	3	6,0	✓	0,18
15U1G040043X8R00	40	29	43	8,4	M16	3	4,0	✓	0,22

SHET110502FR-P

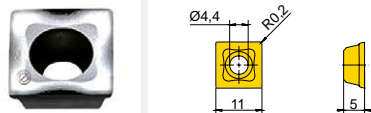

SHET110505FR-P

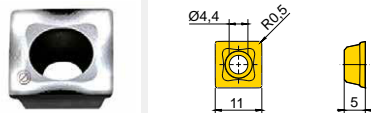

SHET110508FR-P

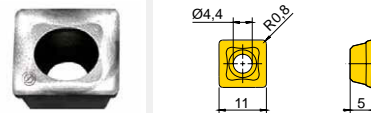

SHET110516FR-P

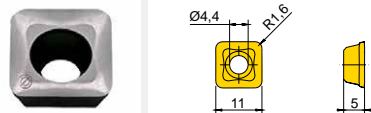

SHET110524FN-P

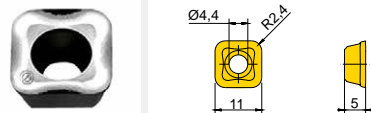

SHET110532FN-P

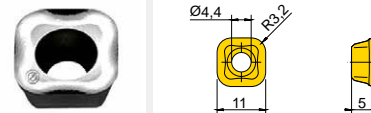

SHET110540FN-P

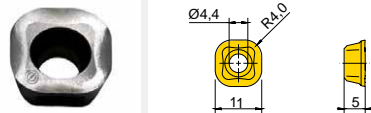

Artikel-Nr. Designation	fz(min/max)	Ausführung Design	Qualität Grade	IN15K						
SHET110502FR-P	0,05/0,30	NE-Geometrie, poliert R0,2 / non-ferrous geometry, polished R0,2	●							
SHET110505FR-P	0,05/0,30	NE-Geometrie, poliert R0,5 / non-ferrous geometry, polished R0,5	●							
SHET110508FR-P	0,05/0,30	NE-Geometrie, poliert R0,8 / non-ferrous geometry, polished R0,8	●							
SHET110516FR-P	0,05/0,30	NE-Geometrie, poliert R1,6 / non-ferrous geometry, polished R1,6	●							
SHET110524FN-P	0,05/0,30	NE-Geometrie, poliert R2,4 / non-ferrous geometry, polished R2,4	●							
SHET110532FN-P	0,05/0,30	NE-Geometrie, poliert R3,2 / non-ferrous geometry, polished R3,2	●							
SHET110540FN-P	0,05/0,30	NE-Geometrie, poliert R4,0 / non-ferrous geometry, polished R4,0	●							

● = P ● = M ● = K ● = N ● = S ○ = H

ZUBEHÖR
 SPARE PARTS

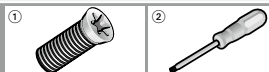

SM40-093-20 (4,5Nm) DS-T15S

① = Spannschraube / Insert screw ② = Schraubendreher / Screw driver

AUFNAHME NACH DIN 8030
ADAPTION ACC. TO DIN 8030

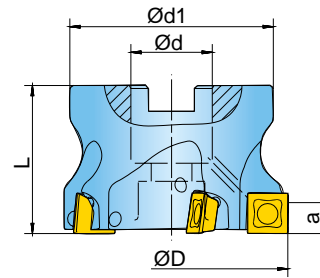
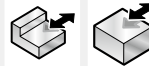

Artikel-Nr. Designation	D	d	d1	L	a	Z			
5H6G050R00	50	22	45	40	8,4	4	2,0	✓	0,24
5H6G063R00	63	22	55	40	8,4	5	1,0	✓	0,45
5H6G080R00	80	27	70	50	8,4	7	0,5	✓	1,08
5H6G100R00	100	32	85	50	8,4	9	0,5	✓	1,72

SHET110502FR-P

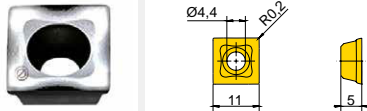

SHET110505FR-P

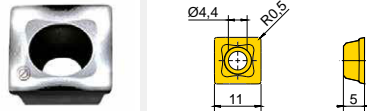

SHET110508FR-P

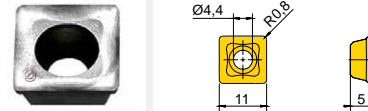

SHET110516FR-P

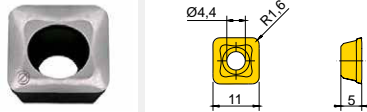

SHET110524FN-P

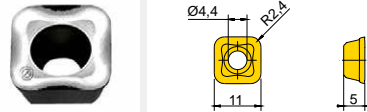

SHET110532FN-P

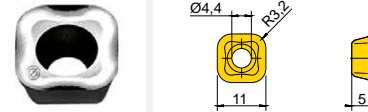

SHET110540FN-P

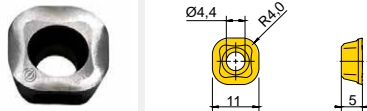

Artikel-Nr. Designation	fz(min/max)	Ausführung Design	Qualität Grade	IN15K							
SHET110502FR-P	0,05/0,30	NE-Geometrie, poliert R0,2 / non-ferrous geometry, polished R0,2	●								
SHET110505FR-P	0,05/0,30	NE-Geometrie, poliert R0,5 / non-ferrous geometry, polished R0,5	●								
SHET110508FR-P	0,05/0,30	NE-Geometrie, poliert R0,8 / non-ferrous geometry, polished R0,8	●								
SHET110516FR-P	0,05/0,30	NE-Geometrie, poliert R1,6 / non-ferrous geometry, polished R1,6	●								
SHET110524FN-P	0,05/0,30	NE-Geometrie, poliert R2,4 / non-ferrous geometry, polished R2,4	●								
SHET110532FN-P	0,05/0,30	NE-Geometrie, poliert R3,2 / non-ferrous geometry, polished R3,2	●								
SHET110540FN-P	0,05/0,30	NE-Geometrie, poliert R4,0 / non-ferrous geometry, polished R4,0	●								

● = P ● = M ● = K ● = N ● = S ○ = H

ZUBEHÖR
SPARE PARTS



SM40-093-20 (4,5Nm) DS-T15S

① = Spannschraube / Insert screw ② = Schraubendreher / Screw driver

ROUGH AIR™ SCHAFTFRÄSER 15X1W...X END MILL 15X1W...X

MIT EINSCHRAUBANSCHLUSS
SCREW-IN TYPE ADAPTION

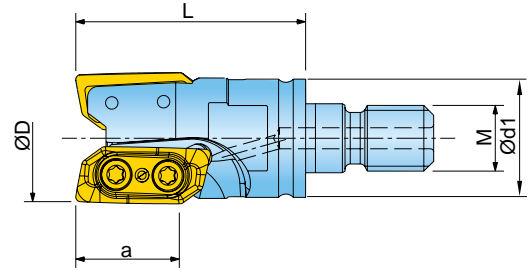
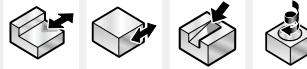

Artikel-Nr. Designation	D	d1	L	a	M	Z			
15X1W020035X6R00	20	18	35	15,5	M10	2	4,6	✓	0,06
15X1W025043X7R00	25	21	43	15,5	M12	2	9,6	✓	0,12
15X1W032043X8R00	32	29	43	15,5	M16	3	12,2	✓	0,21
15X1W040053X8R00	40	29	53	15,5	M16	3	8,6	✓	0,32
15X1W042053X8R00	42	29	53	15,5	M16	3	8,1	✓	0,34

XPET140405FR-P

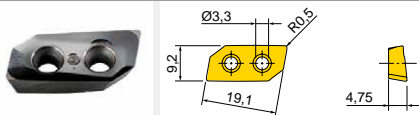

XPET140408FR-P

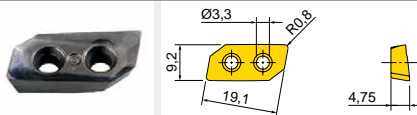

XPET140416FR-P

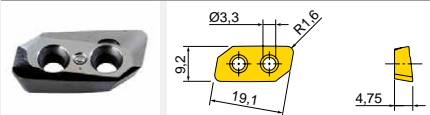

XPET140420FR-P

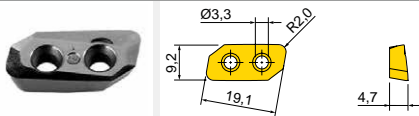

XPET140424FR-P

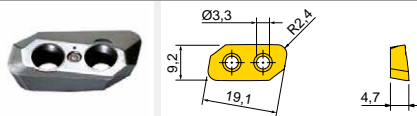

XPET140430FR-P

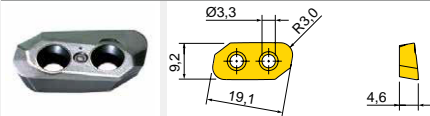

XPET140432FR-P

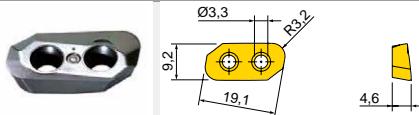

XPET140440FR-P

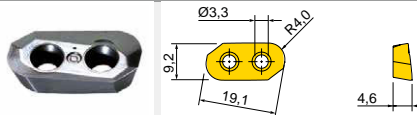

XPET140432FR-PW

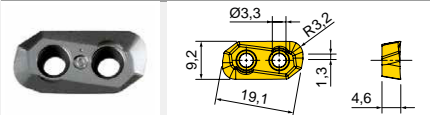

Artikel-Nr. Designation	fz(min/max)	Ausführung Design	Qualität Grade	IN15K							
XPET140405FR-P	0,05/0,30	NE-Geometrie, poliert R0,5 / non-ferrous geometry, polished R0,5	●								
XPET140408FR-P	0,05/0,30	NE-Geometrie, poliert R0,8 / non-ferrous geometry, polished R0,8	●								
XPET140416FR-P	0,05/0,30	NE-Geometrie, poliert R1,6 / non-ferrous geometry, polished R1,6	●								
XPET140420FR-P	0,05/0,30	NE-Geometrie, poliert R2,0 / non-ferrous geometry, polished R2,0	●								
XPET140424FR-P	0,05/0,30	NE-Geometrie, poliert R2,4 / non-ferrous geometry, polished R2,4	●								
XPET140430FR-P ¹⁾	0,05/0,30	NE-Geometrie, poliert R3,0 / non-ferrous geometry, polished R3,0	●								
XPET140432FR-P ¹⁾	0,05/0,30	NE-Geometrie, poliert R3,2 / non-ferrous geometry, polished R3,2	●								
XPET140440FR-P ¹⁾	0,05/0,30	NE-Geometrie, poliert R4,0 / non-ferrous geometry, polished R4,0	●								
XPET140432FR-PW ¹⁾	0,05/0,30	Wiper NE-Geometrie R3,2 / Wiper non-ferrous geometry, polished R3,2	●								

¹⁾Fräskörper nachdrehen / Cutter body has to be modified

● = P ● = M ● = K ● = N ● = S ○ = H

ZUBEHÖR
SPARE PARTS

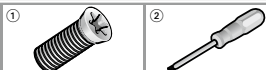

Durchmesserbereich / Diameter Range

20 - 25	SM30-065-00 (2,0Nm) DS-T09S
32 - 42	SM30-082-00 (2,0Nm) DS-T09S

① = Spannschraube / Insert screw ② = Schraubendreher / Screw driver

AUFNAHME NACH DIN 8030
ADAPTION ACC. TO DIN 8030

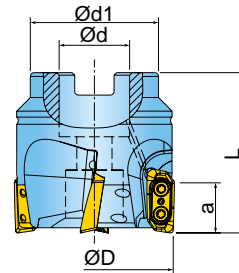
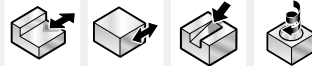

Artikel-Nr. Designation	D	d	d1	L	a	Z			
5X6W050R00	50	22	40	50	15,5	4	6,2	✓	0,36
5X6W052R00	52	22	40	50	15,5	4	5,9	✓	0,39
5X6W063R00	63	27	50	50	15,5	5	4,7	✓	0,59
5X6W066R00	66	27	50	50	15,5	5	4,4	✓	0,65
5X6W080R00	80	27	60	50	15,5	5	3,5	✓	1,08

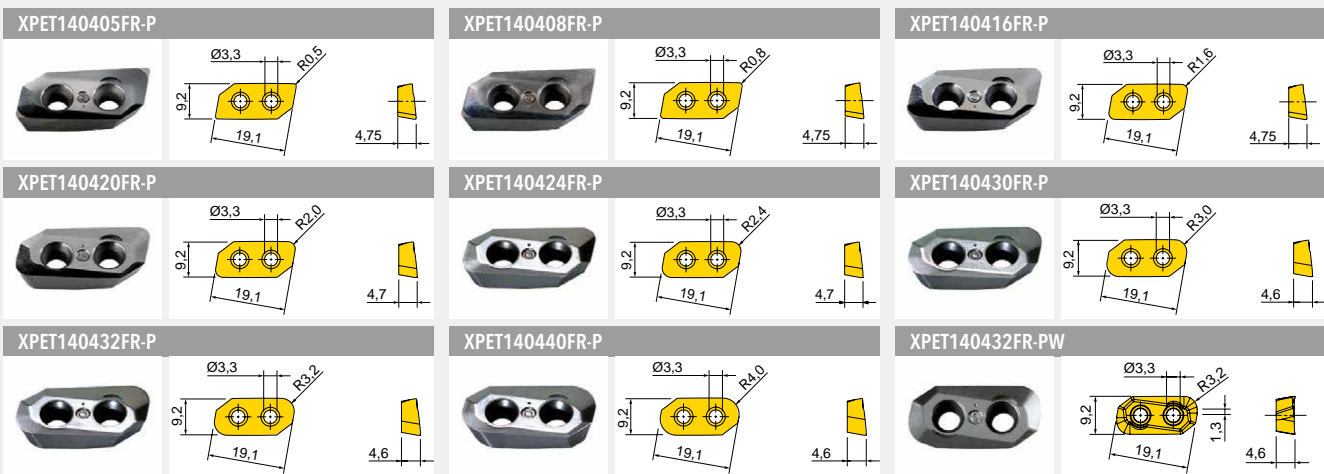

Artikel-Nr. Designation	fz(min/max)	Ausführung Design	Qualität Grade	IN15K							
XPET140405FR-P	0,05/0,30	NE-Geometrie, poliert R0,5 / non-ferrous geometry, polished R0,5	●	●							
XPET140408FR-P	0,05/0,30	NE-Geometrie, poliert R0,8 / non-ferrous geometry, polished R0,8	●	●							
XPET140416FR-P	0,05/0,30	NE-Geometrie, poliert R1,6 / non-ferrous geometry, polished R1,6	●	●							
XPET140420FR-P	0,05/0,30	NE-Geometrie, poliert R2,0 / non-ferrous geometry, polished R2,0	●	●							
XPET140424FR-P	0,05/0,30	NE-Geometrie, poliert R2,4 / non-ferrous geometry, polished R2,4	●	●							
XPET140430FR-P ¹⁾	0,05/0,30	NE-Geometrie, poliert R3,0 / non-ferrous geometry, polished R3,0	●	●							
XPET140432FR-P ¹⁾	0,05/0,30	NE-Geometrie, poliert R3,2 / non-ferrous geometry, polished R3,2	●	●							
XPET140440FR-P ¹⁾	0,05/0,30	NE-Geometrie, poliert R4,0 / non-ferrous geometry, polished R4,0	●	●							
XPET140432FR-PW ¹⁾	0,05/0,30	Wiper NE-Geometrie R3,2 / Wiper non-ferrous geometry, polished R3,2	●	●							

¹⁾ Fräskörper nachdrehen / Cutter body has to be modified

● = P ● = M ● = K ● = N ● = S ○ = H

ZUBEHÖR
SPARE PARTS

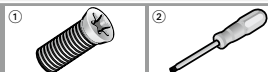

SM30-082-00 (2,0Nm) DS-T09S

① = Spannschraube / Insert screw ② = Schraubendreher / Screw driver

ROUGHAIR™ SCHAFTFRÄSER 15X1W...H5
END MILL 15X1W...H5

AUFNAHME NACH DIN 69893 A
 ADAPTION ACC. TO DIN 69893 A

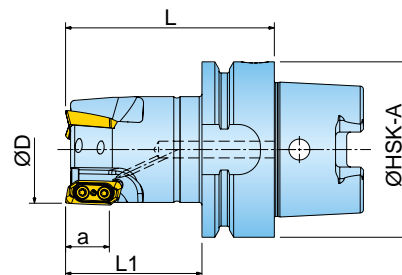
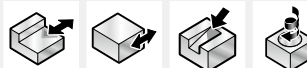

Artikel-Nr. Designation	D	L	L1	a	HSK-A	Z			
15X1W032075H5R00	32	75	48	15,5	63	3	12,2	✓	0,84
15X1W032100H5R00	32	100	73	15,5	63	3	12,2	✓	0,98
15X1W032150H5R00	32	150	123	15,5	63	3	12,2	✓	1,24
15X1W040075H5R00	40	75	48	15,5	63	3	8,6	✓	1,00
15X1W040100H5R00	40	100	73	15,5	63	3	8,6	✓	1,21
15X1W040150H5R00	40	150	123	15,5	63	3	8,6	✓	1,66
15X1W050075H5R00	50	75	48	15,5	63	4	6,2	✓	1,18
15X1W050100H5R00	50	100	73	15,5	63	4	6,2	✓	1,55
15X1W050150H5R00	50	150	123	15,5	63	4	6,2	✓	2,26
15X1W063075H5R00	63	75	48	15,5	63	5	4,7	✓	1,39
15X1W063100H5R00	63	100	73	15,5	63	5	4,7	✓	1,81
15X1W063150H5R00	63	150	123	15,5	63	5	4,7	✓	2,66
15X1W080075H5R00	80	75	48	15,5	63	5	3,5	✓	1,73
15X1W080100H5R00	80	100	73	15,5	63	5	3,5	✓	2,15
15X1W080150H5R00	80	150	123	15,5	63	5	3,5	✓	3,07

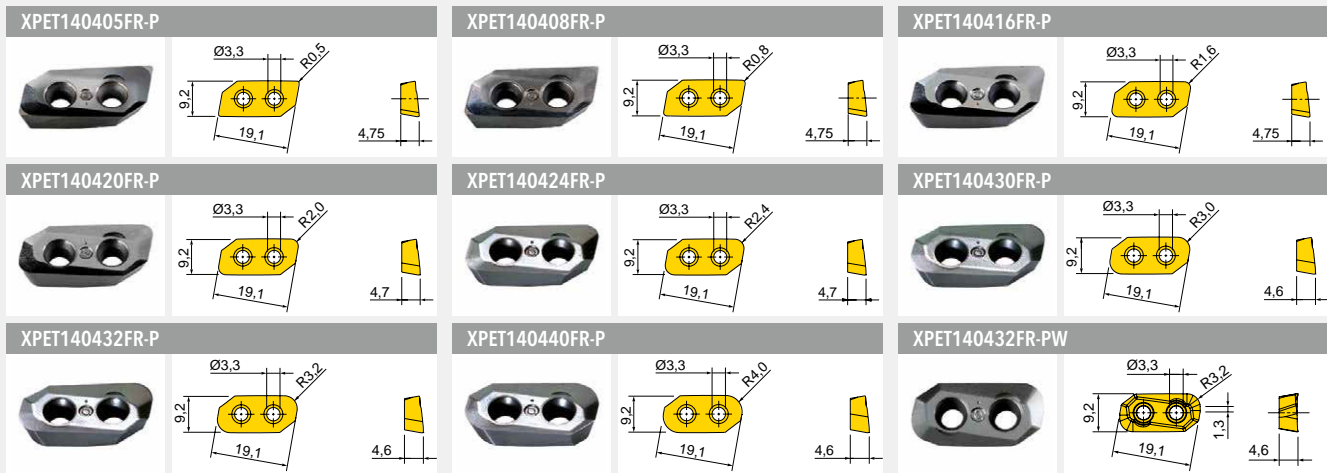

Artikel-Nr. Designation	fz(min/max)	Ausführung Design	Qualität Grade	IN15K									
XPET140405FR-P	0,05/0,30	NE-Geometrie, poliert R0,5 / non-ferrous geometry, polished R0,5	●										
XPET140408FR-P	0,05/0,30	NE-Geometrie, poliert R0,8 / non-ferrous geometry, polished R0,8	●										
XPET140416FR-P	0,05/0,30	NE-Geometrie, poliert R1,6 / non-ferrous geometry, polished R1,6	●										
XPET140420FR-P	0,05/0,30	NE-Geometrie, poliert R2,0 / non-ferrous geometry, polished R2,0	●										
XPET140424FR-P	0,05/0,30	NE-Geometrie, poliert R2,4 / non-ferrous geometry, polished R2,4	●										
XPET140430FR-P ¹⁾	0,05/0,30	NE-Geometrie, poliert R3,0 / non-ferrous geometry, polished R3,0	●										
XPET140432FR-P ¹⁾	0,05/0,30	NE-Geometrie, poliert R3,2 / non-ferrous geometry, polished R3,2	●										
XPET140440FR-P ¹⁾	0,05/0,30	NE-Geometrie, poliert R4,0 / non-ferrous geometry, polished R4,0	●										
XPET140432FR-PW ¹⁾	0,05/0,30	Wiper NE-Geometrie R3,2 / Wiper non-ferrous geometry, polished R3,2	●										

¹⁾Fräskörper nachdrehen / Cutter body has to be modified

● = P ● = M ● = K ● = N ● = S ○ = H

ZUBEHÖR
SPARE PARTS



SM30-082-00 (2,0Nm) DS-T09S

① = Spannschraube / Insert screw ② = Schraubendreher / Screw driver

ROUGHAIR™ SCHAFTFRÄSER 15X1W...H7
END MILL 15X1W...H7

AUFNAHME NACH DIN 69893 A
 ADAPTION ACC. TO DIN 69893 A

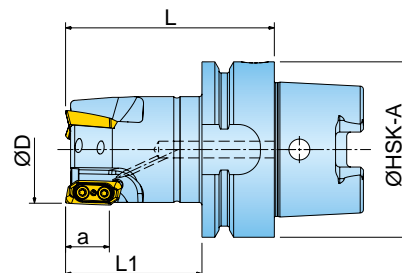
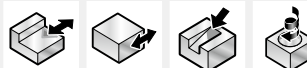

Artikel-Nr. Designation	D	L	L1	a	HSK-A	Z			
15X1W032075H7R00	32	75	48	15,5	80	3	12,2	✓	1,32
15X1W032100H7R00	32	100	73	15,5	80	3	12,2	✓	1,44
15X1W032150H7R00	32	150	123	15,5	80	3	12,2	✓	1,71
15X1W040075H7R00	40	75	48	15,5	80	3	8,6	✓	1,42
15X1W040100H7R00	40	100	73	15,5	80	3	8,6	✓	1,64
15X1W040150H7R00	40	150	123	15,5	80	3	8,6	✓	2,08
15X1W050075H7R00	50	75	48	15,5	80	4	6,2	✓	1,62
15X1W050100H7R00	50	100	73	15,5	80	4	6,2	✓	1,98
15X1W050150H7R00	50	150	123	15,5	80	4	6,2	✓	2,60
15X1W063075H7R00	63	75	48	15,5	80	5	4,7	✓	1,95
15X1W063100H7R00	63	100	73	15,5	80	5	4,7	✓	2,53
15X1W063150H7R00	63	150	123	15,5	80	5	4,7	✓	3,67
15X1W080075H7R00	80	75	48	15,5	80	5	3,5	✓	2,37
15X1W080100H7R00	80	100	73	15,5	80	5	3,5	✓	3,05
15X1W080150H7R00	80	150	123	15,5	80	5	3,5	✓	4,41

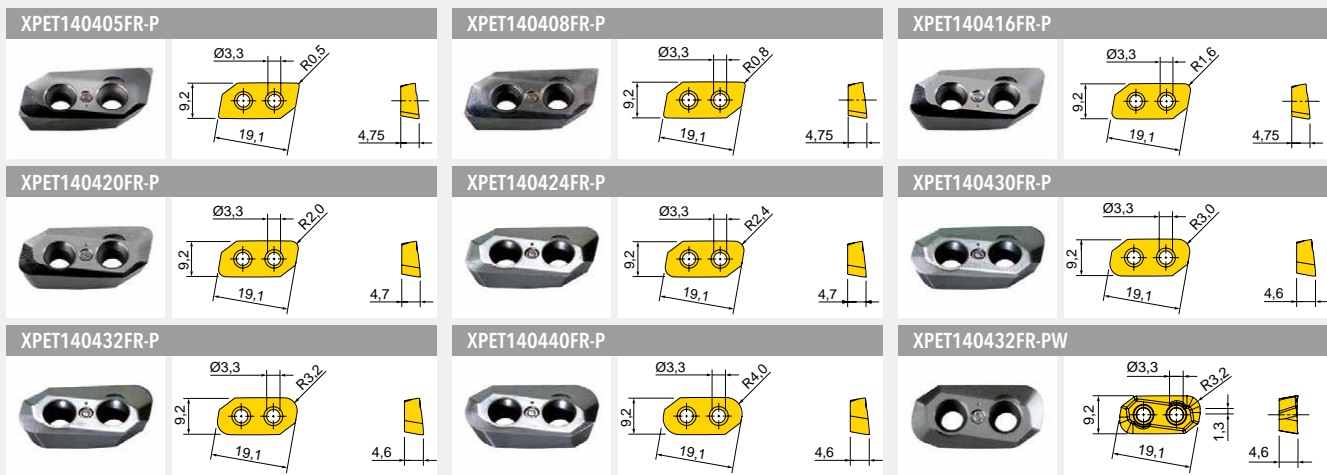

Artikel-Nr. Designation	fz(min/max)	Ausführung Design	Qualität Grade	IN15K								
XPET140405FR-P	0,05/0,30	NE-Geometrie, poliert R0,5 / non-ferrous geometry, polished R0,5	●									
XPET140408FR-P	0,05/0,30	NE-Geometrie, poliert R0,8 / non-ferrous geometry, polished R0,8	●									
XPET140416FR-P	0,05/0,30	NE-Geometrie, poliert R1,6 / non-ferrous geometry, polished R1,6	●									
XPET140420FR-P	0,05/0,30	NE-Geometrie, poliert R2,0 / non-ferrous geometry, polished R2,0	●									
XPET140424FR-P	0,05/0,30	NE-Geometrie, poliert R2,4 / non-ferrous geometry, polished R2,4	●									
XPET140430FR-P ¹⁾	0,05/0,30	NE-Geometrie, poliert R3,0 / non-ferrous geometry, polished R3,0	●									
XPET140432FR-P ¹⁾	0,05/0,30	NE-Geometrie, poliert R3,2 / non-ferrous geometry, polished R3,2	●									
XPET140440FR-P ¹⁾	0,05/0,30	NE-Geometrie, poliert R4,0 / non-ferrous geometry, polished R4,0	●									
XPET140432FR-PW ¹⁾	0,05/0,30	Wiper NE-Geometrie R3,2 / Wiper non-ferrous geometry, polished R3,2	●									

¹⁾Fräskörper nachdrehen / Cutter body has to be modified

● = P ● = M ● = K ● = N ● = S ○ = H

ZUBEHÖR
SPARE PARTS

SM30-082-00 (2,0Nm) DS-T09S

① = Spannschraube / Insert screw ② = Schraubendreher / Screw driver

ROUGHAIR™ SCHAFTFRÄSER 15X1W...H9
END MILL 15X1W...H9

AUFNAHME NACH DIN 69893 A
 ADAPTION ACC. TO DIN 69893 A

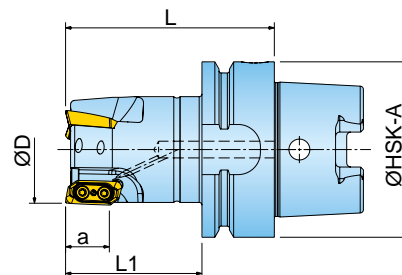
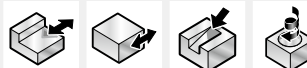

Artikel-Nr. Designation	D	L	L1	a	HSK-A	Z			
15X1W032075H9R00	32	75	48	15,5	50	3	12,2	✓	0,59
15X1W032100H9R00	32	100	73	15,5	50	3	12,2	✓	0,72
15X1W032150H9R00	32	150	123	15,5	50	3	12,2	✓	1,00
15X1W040075H9R00	40	75	48	15,5	50	3	8,6	✓	0,73
15X1W040100H9R00	40	100	73	15,5	50	3	8,6	✓	0,96
15X1W040150H9R00	40	150	123	15,5	50	3	8,6	✓	1,41
15X1W050075H9R00	50	75	48	15,5	50	4	6,2	✓	0,85
15X1W050100H9R00	50	100	73	15,5	50	4	6,2	✓	1,12
15X1W050150H9R00	50	150	123	15,5	50	4	6,2	✓	1,64
15X1W063075H9R00	63	75	48	15,5	50	5	4,7	✓	1,00
15X1W063100H9R00	63	100	73	15,5	50	5	4,7	✓	1,30
15X1W063150H9R00	63	150	123	15,5	50	5	4,7	✓	1,83
15X1W080075H9R00	80	75	48	15,5	50	5	3,5	✓	1,32
15X1W080100H9R00	80	100	73	15,5	50	5	3,5	✓	1,65
15X1W080150H9R00	80	150	123	15,5	50	5	3,5	✓	2,29

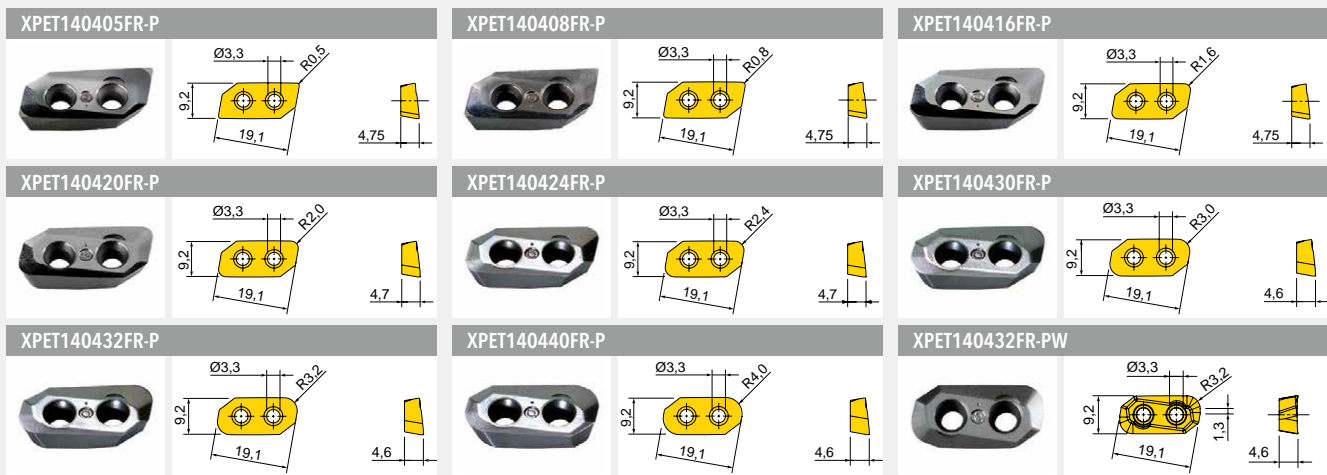

Artikel-Nr. Designation	fz(min/max)	Ausführung Design	Qualität Grade	IN15K									
XPET140405FR-P	0,05/0,30	NE-Geometrie, poliert R0,5 / non-ferrous geometry, polished R0,5	●										
XPET140408FR-P	0,05/0,30	NE-Geometrie, poliert R0,8 / non-ferrous geometry, polished R0,8	●										
XPET140416FR-P	0,05/0,30	NE-Geometrie, poliert R1,6 / non-ferrous geometry, polished R1,6	●										
XPET140420FR-P	0,05/0,30	NE-Geometrie, poliert R2,0 / non-ferrous geometry, polished R2,0	●										
XPET140424FR-P	0,05/0,30	NE-Geometrie, poliert R2,4 / non-ferrous geometry, polished R2,4	●										
XPET140430FR-P ¹⁾	0,05/0,30	NE-Geometrie, poliert R3,0 / non-ferrous geometry, polished R3,0	●										
XPET140432FR-P ¹⁾	0,05/0,30	NE-Geometrie, poliert R3,2 / non-ferrous geometry, polished R3,2	●										
XPET140440FR-P ¹⁾	0,05/0,30	NE-Geometrie, poliert R4,0 / non-ferrous geometry, polished R4,0	●										
XPET140432FR-PW ¹⁾	0,05/0,30	Wiper NE-Geometrie R3,2 / Wiper non-ferrous geometry, polished R3,2	●										

¹⁾Fräskörper nachdrehen / Cutter body has to be modified

● = P ● = M ● = K ● = N ● = S ○ = H

ZUBEHÖR
SPARE PARTS

SM30-082-00 (2,0Nm) DS-T09S

① = Spannschraube / Insert screw ② = Schraubendreher / Screw driver

HIPOS^oALU™ SCHAFTFRÄSER 1AX2K...X
END MILL 1AX2K...X

MIT EINSCHRAUBANSCHLUSS
SCREW-IN TYPE ADAPTION

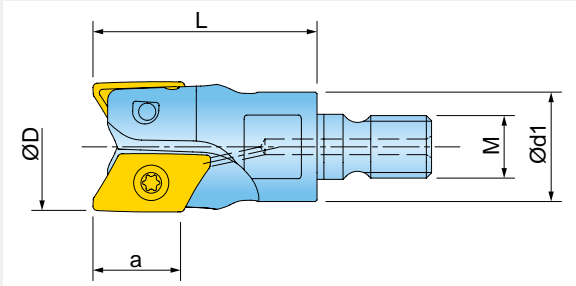

Artikel-Nr. Designation	D	d1	L	a	M	Z			
1AX2K025043X7R00	25	21	43	16	12	2	23,5	✓	0,09
1AX2K032043X8R00	32	29	43	16	16	3	14,5	✓	0,17
1AX2K040043X8R00	40	29	43	16	16	3	10	✓	0,22

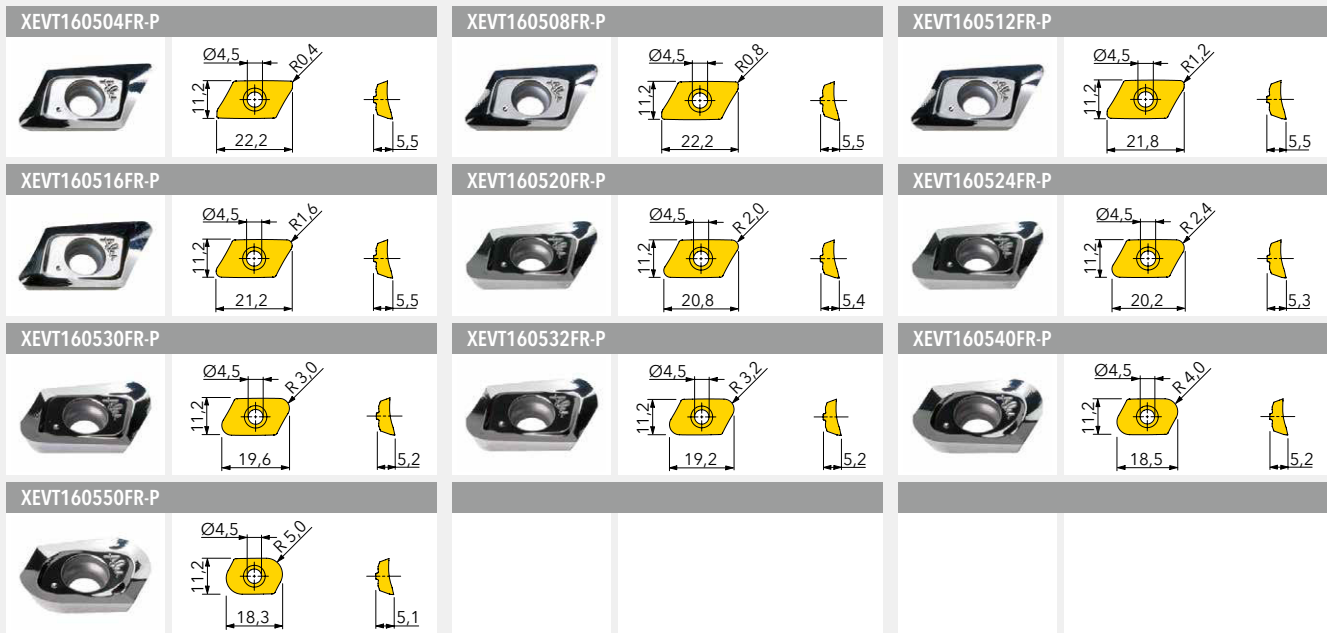

Artikel-Nr. Designation	fz(min/max)	Ausführung Design	Qualität Grade	IN10K							
XEVT160504FR-P	0,05/0,35	NE-Geometrie, poliert R0,4 / non-ferrous geometry, polished R0,4	●								
XEVT160508FR-P	0,05/0,35	NE-Geometrie, poliert R0,8 / non-ferrous geometry, polished R0,8	●								
XEVT160512FR-P	0,05/0,35	NE-Geometrie, poliert R1,2 / non-ferrous geometry, polished R1,2	●								
XEVT160516FR-P	0,05/0,35	NE-Geometrie, poliert R1,6 / non-ferrous geometry, polished R1,6	●								
XEVT160520FR-P	0,05/0,35	NE-Geometrie, poliert R2,0 / non-ferrous geometry, polished R2,0	●								
XEVT160524FR-P	0,05/0,35	NE-Geometrie, poliert R2,4 / non-ferrous geometry, polished R2,4	●								
XEVT160530FR-P	0,05/0,35	NE-Geometrie, poliert R3,0 / non-ferrous geometry, polished R3,0	●								
XEVT160532FR-P	0,05/0,35	NE-Geometrie, poliert R3,2 / non-ferrous geometry, polished R3,2	●								
XEVT160540FR-P¹⁾	0,05/0,35	NE-Geometrie, poliert R4,0 / non-ferrous geometry, polished R4,0	●								
XEVT160550FR-P¹⁾	0,05/0,35	NE-Geometrie, poliert R5,0 / non-ferrous geometry, polished R5,0	●								

¹⁾Fräskörper nachdrehen / Cutter body has to be modified

● = P ● = M ● = K ● = N ● = S ○ = H

ZUBEHÖR SPARE PARTS	①	②
Durchmesserbereich / Diameter Range		
25	SM40-085-20 (4,5Nm) DS-T15T	
32 - 40	SM40-093-21 (4,5Nm) DS-T15T	

① = Spannschraube / Insert screw ② = Schraubendreher / Screw driver

AUFNAHME NACH DIN 8030
ADAPTION ACC. TO DIN 8030

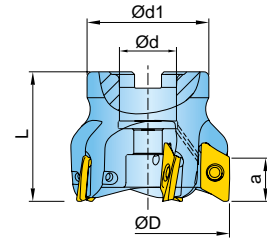

Artikel-Nr. Designation	D	d	d1	L	a	Z			
AX2K040R00	40	16	38	50	16	3	10	✓	0,21
AX2K050R00	50	22	45	50	16	4	7,5	✓	0,30
AX2K063R00	63	22	47	50	16	5	5,5	✓	0,50
AX2K080R00	80	27	58	50	16	5	4,5	✓	0,82
AX2K100R00	100	32	66	63	16	6	3,3	✓	1,50
AX2K125R00	125	40	85	63	16	7	2,5	✓	2,50

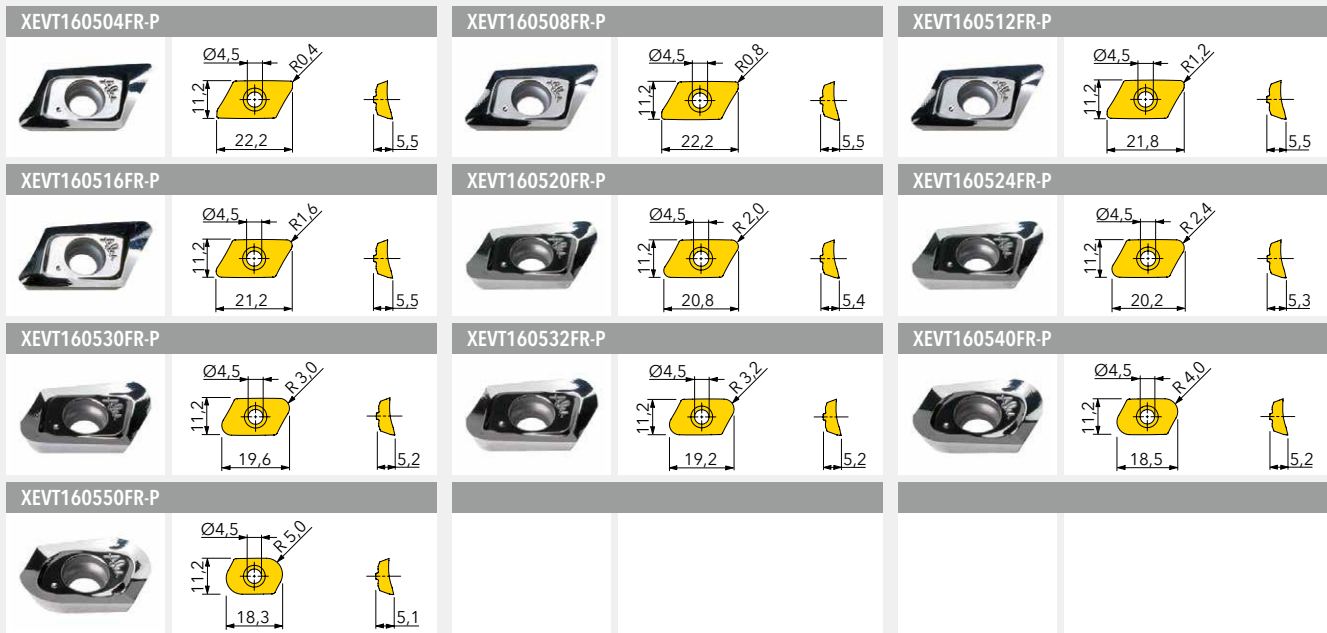

Artikel-Nr. Designation	fz(min/max)	Ausführung Design	Qualität Grade	IN10K								
XEVT160504FR-P	0,05/0,35	NE-Geometrie, poliert R0,4 / non-ferrous geometry, polished R0,4	●									
XEVT160508FR-P	0,05/0,35	NE-Geometrie, poliert R0,8 / non-ferrous geometry, polished R0,8	●									
XEVT160512FR-P	0,05/0,35	NE-Geometrie, poliert R1,2 / non-ferrous geometry, polished R1,2	●									
XEVT160516FR-P	0,05/0,35	NE-Geometrie, poliert R1,6 / non-ferrous geometry, polished R1,6	●									
XEVT160520FR-P	0,05/0,35	NE-Geometrie, poliert R2,0 / non-ferrous geometry, polished R2,0	●									
XEVT160524FR-P	0,05/0,35	NE-Geometrie, poliert R2,4 / non-ferrous geometry, polished R2,4	●									
XEVT160530FR-P	0,05/0,35	NE-Geometrie, poliert R3,0 / non-ferrous geometry, polished R3,0	●									
XEVT160532FR-P	0,05/0,35	NE-Geometrie, poliert R3,2 / non-ferrous geometry, polished R3,2	●									
XEVT160540FR-P¹⁾	0,05/0,35	NE-Geometrie, poliert R4,0 / non-ferrous geometry, polished R4,0	●									
XEVT160550FR-P¹⁾	0,05/0,35	NE-Geometrie, poliert R5,0 / non-ferrous geometry, polished R5,0	●									

¹⁾Fräskörper nachdrehen / Cutter body has to be modified

● = P ● = M ● = K ● = N ● = S ○ = H

ZUBEHÖR
SPARE PARTS

①

②

SM40-093-21 (4,5Nm) DS-T15T

① = Spannschraube / Insert screw ② = Schraubendreher / Screw driver

MIT EINSCHRAUBANSCHLUSS
 SCREW-IN TYPE ADAPTION

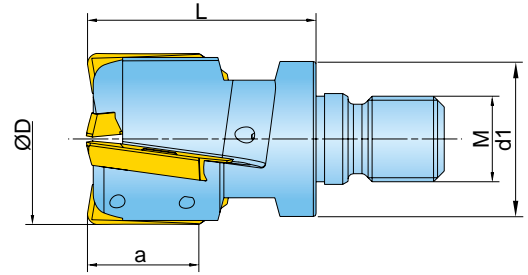
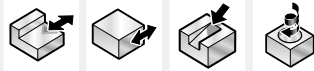

Artikel-Nr. Designation	D	d1	L	a	M	Z			
15X1X025043X7R00	25	21	43	21	M12	1	3,9	✓	0,12
15X1X032043X8R00	32	29	43	21	M16	2	21,0	✓	0,15
15X1X042053X8R00	42	29	53	21	M16	3	10,1	✓	0,20

XEET250408R-P

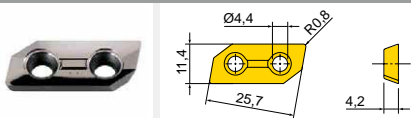

XEET250416R-P

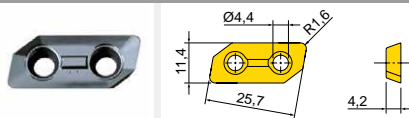

XEET250432R-P

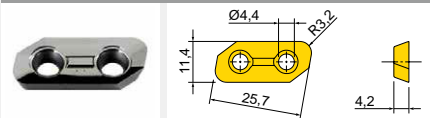

XEET250440R-P

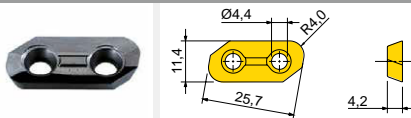

XEET250450R-P

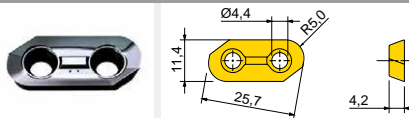

Artikel-Nr. Designation	fz(min/max)	Ausführung Design	Qualität Grade	IN15K						
XEET250408R-P	0,05/0,35	NE-Geometrie, poliert R0,8 / non-ferrous geometry, polished R0,8								
XEET250416R-P	0,05/0,35	NE-Geometrie, poliert R1,6 / non-ferrous geometry, polished R1,6								
XEET250432R-P	0,05/0,35	NE-Geometrie, poliert R3,2 / non-ferrous geometry, polished R3,2								
XEET250440R-P	0,05/0,35	NE-Geometrie, poliert R4,0 / non-ferrous geometry, polished R4,0								
XEET250450R-P ¹⁾	0,05/0,35	NE-Geometrie, poliert R5,0 / non-ferrous geometry, polished R5,0								

¹⁾ Fräskörper nachdrehen / Cutter body has to be modified

● = P ● = M ● = K ● = N ● = S ○ = H

ZUBEHÖR
 SPARE PARTS



SM40-070-00 (4,5Nm) DS-T15S

① = Spannschraube / Insert screw ② = Schraubendreher / Screw driver

AUFNAHME NACH DIN 8030
ADAPTION ACC. TO DIN 8030

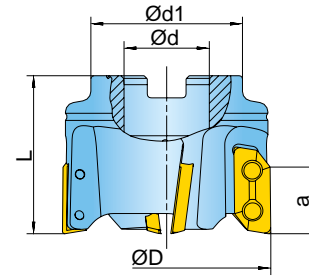
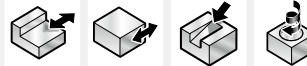

Artikel-Nr. Designation	D	d	d1	L	a	Z			
5X6X050R00	50	22	40	50	21	3	9,1	✓	0,32
5X6X052R00	52	22	40	50	21	3	8,7	✓	0,35
5X6X063R00	63	27	48	50	21	4	6,9	✓	0,55
5X6X066R00	66	27	48	50	21	4	6,5	✓	0,60
5X6X080R00	80	27	60	50	21	5	5,2	✓	1,00
5X6X100R00	100	32	70	50	21	5	3,9		1,60
5X6X125R00	125	40	90	63	21	6	3,0		3,20

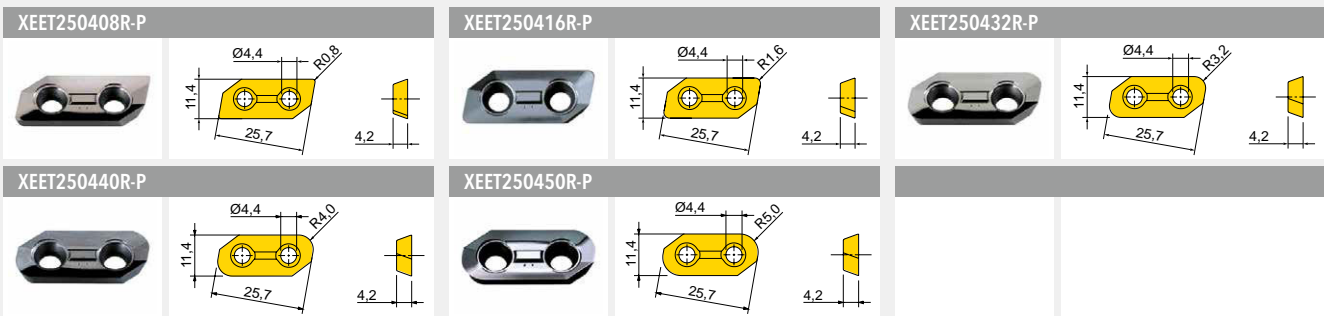

Artikel-Nr. Designation	fz(min/max)	Ausführung Design	Qualität Grade	IN15K							
XEET250408R-P	0,05/0,35	NE-Geometrie, poliert R0,8 / non-ferrous geometry, polished R0,8									
XEET250416R-P	0,05/0,35	NE-Geometrie, poliert R1,6 / non-ferrous geometry, polished R1,6									
XEET250432R-P	0,05/0,35	NE-Geometrie, poliert R3,2 / non-ferrous geometry, polished R3,2									
XEET250440R-P	0,05/0,35	NE-Geometrie, poliert R4,0 / non-ferrous geometry, polished R4,0									
XEET250450R-P¹⁾	0,05/0,35	NE-Geometrie, poliert R5,0 / non-ferrous geometry, polished R5,0									

¹⁾ Fräskörper nachdrehen / Cutter body has to be modified

● = P ● = M ● = K ● = N ● = S ○ = H

ZUBEHÖR
SPARE PARTS



SM40-090-00 (4,5Nm) DS-T15S

① = Spannschraube / Insert screw ② = Schraubendreher / Screw driver

ROUGH AIR™ SCHAFTFRÄSER 15X1Z...H END MILL 15X1Z...H

AUFNAHME NACH DIN 69893 A
ADAPTION ACC. TO DIN 69893 A

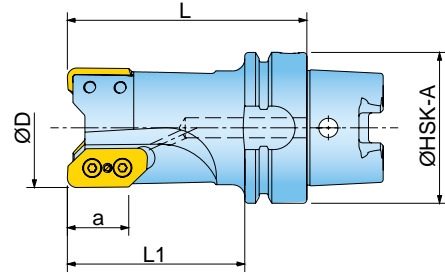
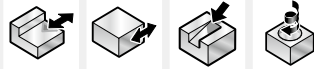

Artikel-Nr. Designation	D	L	L1	a	HSK-A	Z			
15X1Z050100H5R00	50	100	72	25,5	63	2		✓	1,22
15X1Z050100H7R00	50	100	72	25,5	80	2		✓	1,64

XFEB330504R-P

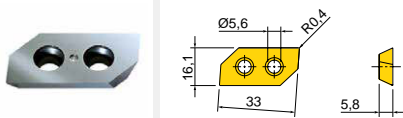

XFEB330508R-P

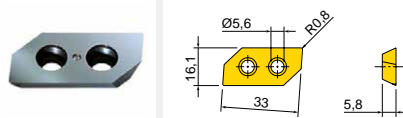

XFEB330516R-P

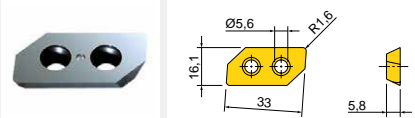

XFEB330532R-P

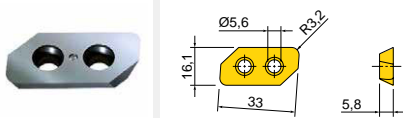

XFEB330540R-P

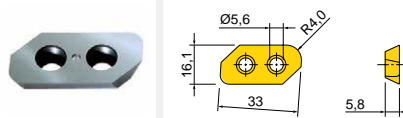

XFEB330550R-P

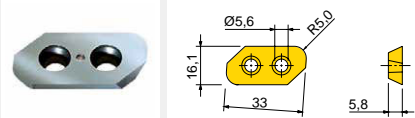

XFEB330564R-P

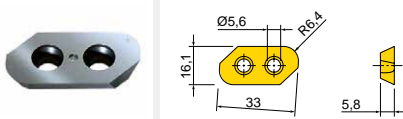

XFEB330508R-PW

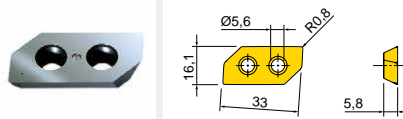

Artikel-Nr. Designation	fz(min/max)	Ausführung Design	Qualität Grade	IN15K						
XFEB330504R-P	0,05/0,40	NE-Geometrie, poliert R0,4 / non-ferrous geometry, polished R0,4	●							
XFEB330508R-P	0,05/0,40	NE-Geometrie, poliert R0,8 / non-ferrous geometry, polished R0,8	●							
XFEB330516R-P	0,05/0,40	NE-Geometrie, poliert R1,6 / non-ferrous geometry, polished R1,6	●							
XFEB330532R-P	0,05/0,40	NE-Geometrie, poliert R3,2 / non-ferrous geometry, polished R3,2	●							
XFEB330540R-P	0,05/0,40	NE-Geometrie, poliert R4,0 / non-ferrous geometry, polished R4,0	●							
XFEB330550R-P	0,05/0,40	NE-Geometrie, poliert R5,0 / non-ferrous geometry, polished R5,0	●							
XFEB330564R-P ¹⁾	0,05/0,40	NE-Geometrie, poliert R6,4 / non-ferrous geometry, polished R6,4	●							
XFEB330508R-PW	0,05/0,40	Wiper NE-Geometrie R0,8 / Wiper non-ferrous geometry, polished R0,8	●							

¹⁾ Fräskörper nachdrehen / Cutter body has to be modified

● = P ● = M ● = K ● = N ● = S ○ = H

ZUBEHÖR
SPARE PARTS



SM50-100-10 (6,0Nm) DS-T20T

① = Spannschraube / Insert screw ② = Schraubendreher / Screw driver

AUFNAHME NACH DIN 8030
 ADAPTION ACC. TO DIN 8030

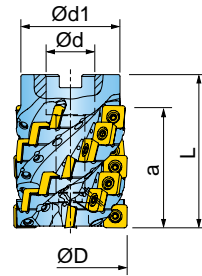

Artikel-Nr. Designation	D	d	d1	L	a	Z	Zeff			
25J3P063066F2R00	63	27	55	85	66,2	28	4	2,0	✓	0,90
25J3P080085F3R00	80	32	75	105	84,6	45	5	1,3	✓	2,14
25J3P100103F4R00	100	40	95	130	103	66	6	1,0	✓	4,65

* fz-Werte siehe Handbuch Schnittwerte für Fräs- und Bohrwerkzeuge / * fz-values see manual „Cutting Data for Milling & Boring Tools“

SDES130515N 	SDES130515N-001 	SDMS130515R-PH
SDXS130515R-PH 	SDXS130515N-HR 	SDES130532R-001
SDES130540R-001 		

Artikel-Nr. Designation	fz(min/max)	Ausführung Design	Qualität Grade	IN2035	IN2505	IN2530	IN4030	IN4035			
SDES130515N	*/*	neutrale Geometrie, gefast R1,5 / neutral geometry, K-land R1,5									
SDES130515N-001	*/*	neutrale Geometrie, scharf R1,5 / neutral geometry, sharp R1,5									
SDMS130515R-PH	*/*	positive Geometrie, gefast R1,5 / positive geometry, chamfered R1,5									
SDXS130515R-PH	*/*	positive Geometrie, gefast R1,5 / positive geometry, chamfered R1,5									
SDXS130515N-HR	*/*	positive Titan-Geometrie, gefast R1,5 / positive titanium geometry R1,5, K-land									
SDES130532R-001	*/*	neutrale Geometrie, scharf R3,2 / neutral geometry, sharp R3,2									
SDES130540R-001 ¹⁾	*/*	neutrale Geometrie, scharf R4,0 / neutral geometry, sharp R4,0									

¹⁾ Fräskörper nachdrehen / Cutter body has to be modified

= P = M = K = N = S = H

ZUBEHÖR
 SPARE PARTS



SM40-100-R0 (4,5Nm) DS-T15S

① = Spannschraube / Insert screw ② = Schraubendreher / Screw driver

AUFNAHME NACH DIN 8030
ADAPTION ACC. TO DIN 8030

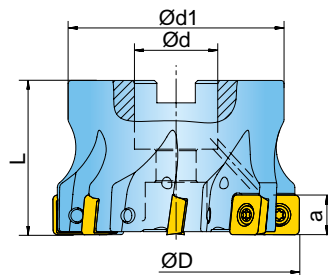
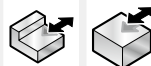

Artikel-Nr. Designation	D	d	d1	L	a	Z			
5J5P050R00	50	22	45	40	11,3	5	3,7	✓	0,30
5J5P063R00	63	22	55	40	11,3	6	2,0	✓	0,48
5J5P080R00	80	27	70	50	11,3	8	1,3	✓	1,06
5J5P100R00	100	32	85	50	11,3	10	1,0	✓	1,70
5J5P125R00	125	40	100	63	11,3	13	0,7	✓	3,20
5J5P160R00	160	40	100	63	11,3	16	0,5	✓	4,42

* fz-Werte siehe Handbuch Schnittwerte für Fräs- und Bohrwerkzeuge / * fz-values see manual „Cutting Data for Milling & Boring Tools“

SDES130515N

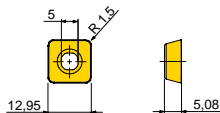

SDES130515N-001

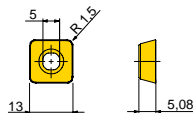

SDMS130515R-PH

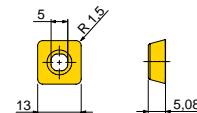

SDXS130515R-PH

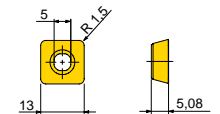

SDXS130515N-HR

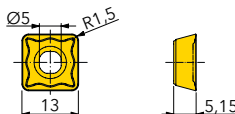

SDES130532R-001

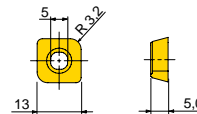

SDES130540R-001

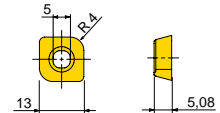

Artikel-Nr. Designation	fz(min/max)	Ausführung Design	Qualität Grade	IN2035	IN2505	IN2530	IN4030	IN4035		
SDES130515N	*/*	neutrale Geometrie, gefast R1,5 / neutral geometry, K-land R1,5								
SDES130515N-001	*/*	neutrale Geometrie, scharf R1,5 / neutral geometry, sharp R1,5								
SDMS130515R-PH	*/*	positive Geometrie, gefast R1,5 / positive geometry, chamfered R1,5								
SDXS130515R-PH	*/*	positive Geometrie, gefast R1,5 / positive geometry, chamfered R1,5								
SDXS130515N-HR	*/*	positive Titan-Geometrie, gefast R1,5 / positive titanium geometry R1,5, K-land								
SDES130532R-001	*/*	neutrale Geometrie, scharf R3,2 / neutral geometry, sharp R3,2								
SDES130540R-001	1) */*	neutrale Geometrie, scharf R4,0 / neutral geometry, sharp R4,0								

1) Fräskörper nachdrehen / Cutter body has to be modified

● = P ● = M ● = K ● = N ● = S ○ = H

ZUBEHÖR
SPARE PARTS

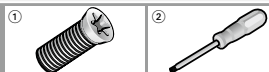

SM40-100-R0 (4,5Nm) DS-T15S

① = Spannschraube / Insert screw ② = Schraubendreher / Screw driver

AUFNAHME NACH DIN 8030
 ADAPTION ACC. TO DIN 8030

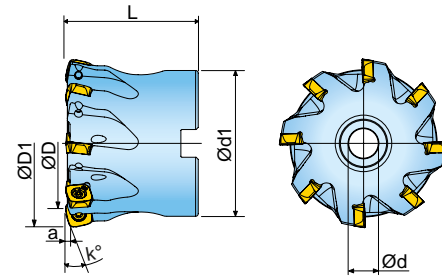

Artikel-Nr. Designation	D	D1	d	d1	L	κ	a	Z			
5G6F050R00	37,8	50	22	45	50	12	1,5	6	1,5	✓	0,43
5G5F050R00 ¹⁾	37,8	50	22	45	50	12	1,5	7	1,5	✓	0,43
5G6F052R00	39,8	52	22	40	50	12	1,5	6	1,3	✓	0,46
5G5F052R00 ¹⁾	39,8	52	22	40	50	12	1,5	7	1,3	✓	0,46
5G6F063R00	50,8	63	22	55	50	12	1,5	7	1,1	✓	0,75
5G5F063R00 ¹⁾	50,8	63	22	55	50	12	1,5	8	1,1	✓	0,75
5G6F066R00	53,8	66	27	50	50	12	1,5	7	1,0	✓	0,80
5G5F066R00 ¹⁾	53,8	66	27	50	50	12	1,5	8	1,0	✓	0,80
5G6F080R00	67,8	80	27	70	50	12	1,5	7	0,6	✓	1,20
5G5F080R00 ¹⁾	67,8	80	27	70	50	12	1,5	9	0,6	✓	1,20
5G6F085R00	72,8	85	27	70	50	12	1,5	8	0,4	✓	1,27
5G5F085R00 ¹⁾	72,8	85	27	70	50	12	1,5	10	0,4	✓	1,27

Programmierradius R2,5 / Programming radius 2,5 mm / * fz-values see manual „Cutting Data for Milling & Boring Tools“

¹⁾enge Teilung / Narrow spacing

SDXS0904MPR-MR		SDXS0904MPR-MRH		SDXS0904MPR-MR1		SDXS0904MPR-MM				
Artikel-Nr. Designation	fz(min/max)	Ausführung Design	Qualität Grade	IN2504	IN2505	IN2530	IN4005	IN4030	IN4035	IN7035
SDXS0904MPR-MR	0,50/1,50	neutrale Geometrie, konvex, gefast / neutral geometry convex, chamfered								
SDXS0904MPR-MRH	0,50/1,50	neutrale Geometrie, konvex, gefast / neutral geometry convex, chamfered								
SDXS0904MPR-MR1	0,50/1,50	neutrale Geometrie, konvex, scharf / neutral geometry convex, sharp								
SDXS0904MPR-MM	0,50/1,50	positive Geometrie, konvex, gefast / positive geometry convex, chamfered								

● = P ● = M ● = K ● = N ● = S ○ = H



SM30-075-R0 (2,0Nm) DS-T09S

① = Spannschraube / Insert screw ② = Schraubendreher / Screw driver

MIT EINSCHRAUBANSCHLUSS
SCREW-IN TYPE ADAPTION

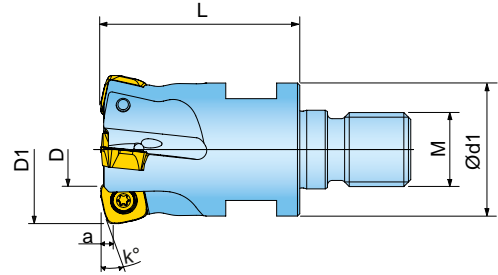

Artikel-Nr. Designation	D	D1	d1	L	κ	a	M	Z			
15G1F025035X7R00	12,9	25	21	35	12	1,5	M12	3	5,5	✓	0,09
15G1F030043X8R00	17,9	30	29	43	12	1,5	M16	3	3,5	✓	0,15
15G1F032043X8R00	19,9	32	29	43	12	1,5	M16	4	3,3	✓	0,20
15G1F035043X8R00	22,9	35	29	43	12	1,5	M16	4	2,6	✓	0,22
15G1F040043X8R00	27,8	40	29	43	12	1,5	M16	5	2,2	✓	0,24
15G1F042043X8R00	29,8	42	29	43	12	1,5	M16	5	2,0	✓	0,26

Programmierradius R2,5 / Programming radius 2,5 mm / * fz-values see manual „Cutting Data for Milling & Boring Tools“

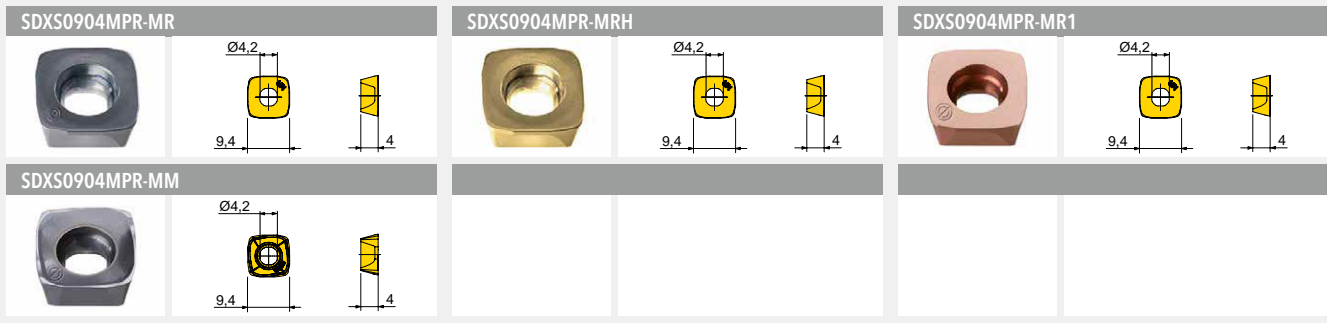

Artikel-Nr. Designation	fz(min/max)	Ausführung Design	Qualität Grade	IN2504	IN2505	IN2530	IN4005	IN4030	IN4035	IN7035
SDXS0904MPR-MR	0,50/1,50	neutrale Geometrie, konvex, gefast / neutral geometry convex, chamfered		●	●	●	●	●	●	
SDXS0904MPR-MRH	0,50/1,50	neutrale Geometrie, konvex, gefast / neutral geometry convex, chamfered	●							
SDXS0904MPR-MR1	0,50/1,50	neutrale Geometrie, konvex, scharf / neutral geometry convex, sharp							●	●
SDXS0904MPR-MM	0,50/1,50	positive Geometrie, konvex, gefast / positive geometry convex, chamfered		●			●	●	●	

● = P ● = M ● = K ● = N ● = S ○ = H

ZUBEHÖR
SPARE PARTS

①

②

SM30-075-R0 (2,0Nm) DS-T09S

① = Spannschraube / Insert screw ② = Schraubendreher / Screw driver

MIT EINSCHRAUBANSCHLUSS
 SCREW-IN TYPE ADAPTION

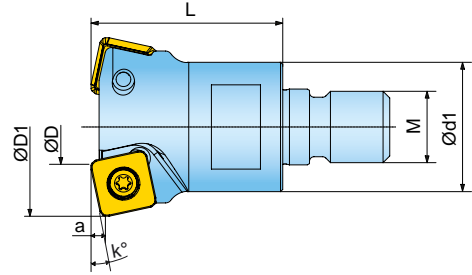

Artikel-Nr. Designation	D	D1	d1	L	κ	a	M	Z			
15M1P032043X8R00	11	32	29	43	12	2	M16	2	10	✓	0,17
15M1P035043X8R00	14	35	29	43	12	2	M16	2	8	✓	0,17
15M1P040043X8R00	19	40	29	43	12	2	M16	3	5	✓	0,19
15M1P042043X8R00	21	42	29	43	12	2	M16	3	5	✓	0,20
15M1P032043X8R01 ¹⁾	11	32	29	43	12	2	M16	2	10	✓	0,17
15M1P035043X8R01 ¹⁾	14	35	29	43	12	2	M16	2	8	✓	0,17
15M1P042043X8R01 ¹⁾	21	42	29	43	12	2	M16	3	5	✓	0,20

* fz-Werte / Programmerradien siehe Handbuch Schnittwerte für Fräs- und Bohrwerkzeuge / * fz-values / programming radii see manual „Cutting Data for Milling & Boring Tools“

¹⁾ bei Verwendung *MPR-WSP Geometrie eff. Durchmesser (D1) / for * MPR-Insert geometry is effective diameter (D)

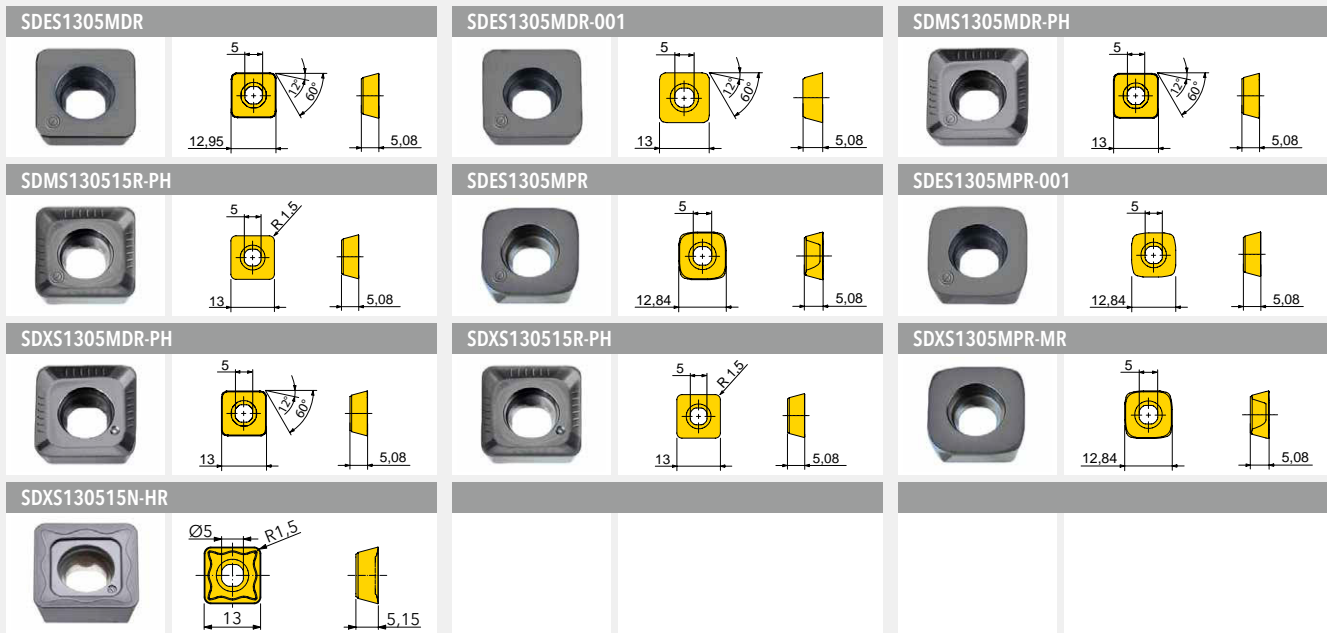

Artikel-Nr. Designation	fz(min/max)	Ausführung Design	Qualität Grade	IN2035	IN2505	IN4005	IN4030	IN4035			
SDES1305MDR	*/*	neutrale Geometrie, gefast / neutral geometry, chamfered			●						
SDES1305MDR-001	*/*	neutrale Geometrie, scharf / neutral geometry, sharp		●							
SDMS1305MDR-PH	*/*	positive Geometrie, gefast / positive geometry, chamfered		●		●	●	●			
SDMS130515R-PH	*/*	positive Geometrie, gefast R1,5 / positive geometry, chamfered R1,5		●			●	●			
SDES1305MPR	*/*	neutrale Geometrie, konvex, gefast / neutral geometry convex, chamfered		●	●			●			
SDES1305MPR-001	*/*	neutrale Geometrie, konvex, scharf / neutral geometry convex, sharp		●	●			●			
SDXS1305MDR-PH	*/*	positive Geometrie, gefast / positive geometry, chamfered					●	●			
SDXS130515R-PH	*/*	positive Geometrie, gefast R1,5 / positive geometry, chamfered R1,5					●	●			
SDXS1305MPR-MR	*/*	neutrale Geometrie, konvex, gefast / neutral geometry convex, chamfered				●	●				
SDXS130515N-HR	*/*	positive Titan-Geometrie, gefast R1,5 / positive titanium geometry R1,5, K-land	●								

● = P ● = M ● = K ● = N ● = S ○ = H

ZUBEHÖR
SPARE PARTS



SM40-100-R0 (4,5Nm) DS-T15S

① = Spannschraube / Insert screw ② = Schraubendreher / Screw driver

AUFNAHME NACH DIN 8030
 ADAPTION ACC. TO DIN 8030

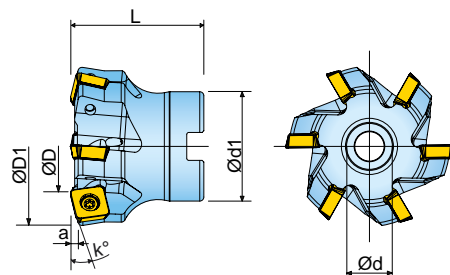

Artikel-Nr.
 Designation

D D1 d d1 L κ a Z



Artikel-Nr. Designation	D	D1	d	d1	L	κ	a	Z			
5M6P050R00	29	50	22	45	50	12	2	4	3,5	✓	0,34
5M5P050R00 ¹⁾	29	50	22	45	50	12	2	5	3,5	✓	0,33
5M6P052R00	31	52	22	40	50	12	2	4	3	✓	0,29
5M5P052R00 ¹⁾	31	52	22	40	50	12	2	5	3	✓	0,28
5M6P063R00	42	63	22	55	50	12	2	5	2,5	✓	0,57
5M5P063R00 ¹⁾	42	63	22	55	50	12	2	6	2,5	✓	0,60
5M6P066R00	45	66	27	48	50	12	2	5	2	✓	0,48
5M5P066R00 ¹⁾	45	66	27	48	50	12	2	6	2	✓	0,50
5M6P080R00	59	80	27	70	50	12	2	6	1	✓	0,97
5M5P080R00 ¹⁾	59	80	27	70	50	12	2	8	1	✓	1,01
5M6P100R00	79	100	32	85	55	12	2	7	0,5	✓	1,75
5M5P100R00 ¹⁾	79	100	32	85	55	12	2	9	0,5	✓	1,74
5M5P052R01 ¹⁾²⁾	31	52	22	40	50	12	2	5	3	✓	0,28
5M5P066R01 ¹⁾²⁾	45	66	27	48	50	12	2	6	2	✓	0,50
5M5P080R01 ¹⁾²⁾	59	80	27	70	50	12	2	8	1	✓	1,01
5M5P100R01 ¹⁾²⁾	79	100	32	85	55	12	2	9	0,5	✓	1,74

* fz-Werte / Programmierradien siehe Handbuch Schnittwerte für Fräs- und Bohrwerkzeuge / * fz-values see manual „Cutting Data for Milling & Boring Tools“

¹⁾enge Teilung / Narrow spacing; ²⁾bei Verwendung *MPR-WSP Geometrie eff. Durchmesser (D1) / for * MPR-Insert geometry is effective diameter (D1)

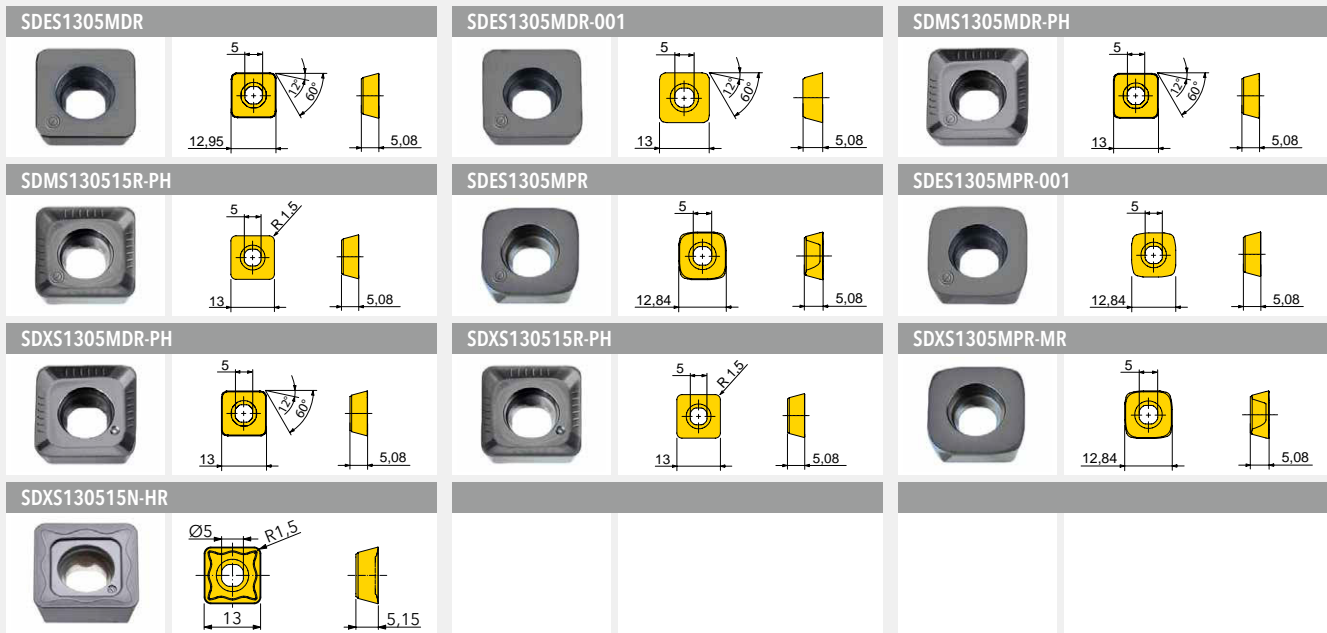

Artikel-Nr. Designation	fz(min/max)	Ausführung Design	Qualität Grade	IN2035	IN2505	IN4005	IN4030	IN4035			
SDES1305MDR	*/*	neutrale Geometrie, gefast / neutral geometry, chamfered			●						
SDES1305MDR-001	*/*	neutrale Geometrie, scharf / neutral geometry, sharp		●							
SDMS1305MDR-PH	*/*	positive Geometrie, gefast / positive geometry, chamfered		●	●	●	●	●			
SDMS130515R-PH	*/*	positive Geometrie, gefast R1,5 / positive geometry, chamfered R1,5		●	●		●	●			
SDES1305MPR	*/*	neutrale Geometrie, konvex, gefast / neutral geometry convex, chamfered		●	●	●		●			
SDES1305MPR-001	*/*	neutrale Geometrie, konvex, scharf / neutral geometry convex, sharp		●	●	●		●			
SDXS1305MDR-PH	*/*	positive Geometrie, gefast / positive geometry, chamfered					●	●			
SDXS130515R-PH	*/*	positive Geometrie, gefast R1,5 / positive geometry, chamfered R1,5					●	●			
SDXS1305MPR-MR	*/*	neutrale Geometrie, konvex, gefast / neutral geometry convex, chamfered				●	●				
SDXS130515N-HR	*/*	positive Titan-Geometrie, gefast R1,5 / positive titanium geometry R1,5, K-land	●								

● = P ● = M ● = K ● = N ● = S ○ = H

ZUBEHÖR
SPARE PARTS



SM40-100-R0 (4,5Nm) DS-T15S

① = Spannschraube / Insert screw ② = Schraubendreher / Screw driver

AUFNAHME NACH DIN 8030
ADAPTION ACC. TO DIN 8030

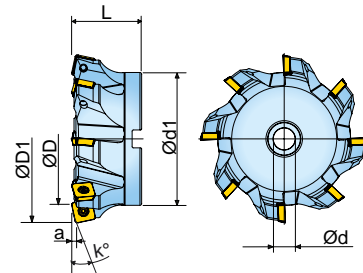

Artikel-Nr. Designation	D	D1	d	d1	LK	L	κ	a	Z			
5G6M080R00	48,6	80	27	70	-	55	12	3	5	3,5	✓	1,01
5G5M080R00 ¹⁾	48,6	80	27	70	-	55	12	3	6	3,5	✓	1,02
5G6M100R00	68,6	100	32	85	-	55	12	3	6	2,5	✓	1,63
5G5M100R00 ¹⁾	68,6	100	32	85	-	55	12	3	8	2,5	✓	1,62
5G6M125R00	93,6	125	40	100	-	63	12	3	7	1,5	✓	2,84
5G5M125R00 ¹⁾	93,6	125	40	100	-	63	12	3	9	1,5	✓	2,87
5G6M160R00	128,6	160	40	130	66,7	63	12	3	8	1	✓	4,80
5G5M160R00 ¹⁾	128,6	160	40	130	66,7	63	12	3	10	1	✓	4,82
5G5M080R01 ¹⁾²⁾	48,6	80	27	70	-	55	12	3	6	3,5	✓	1,02
5G5M100R01 ¹⁾²⁾	68,6	100	32	85	-	55	12	3	8	2,5	✓	1,62
5G5M125R01 ¹⁾²⁾	93,6	125	40	100	-	63	12	3	9	1,5	✓	2,87
5G5M160R01 ¹⁾²⁾	128,6	160	40	130	66,7	63	12	3	10	1,0	✓	4,82

* fz-Werte / Programmerradien siehe Handbuch Schnittwerte für Fräs- und Bohrwerkzeuge / * fz-values see manual „Cutting Data for Milling & Boring Tools“

¹⁾enge Teilung / Narrow spacing; ²⁾bei Verwendung *MPR-WSP Geometrie eff. Durchmesser (D1) / for * MPR-Insert geometry is effective diameter (D1)

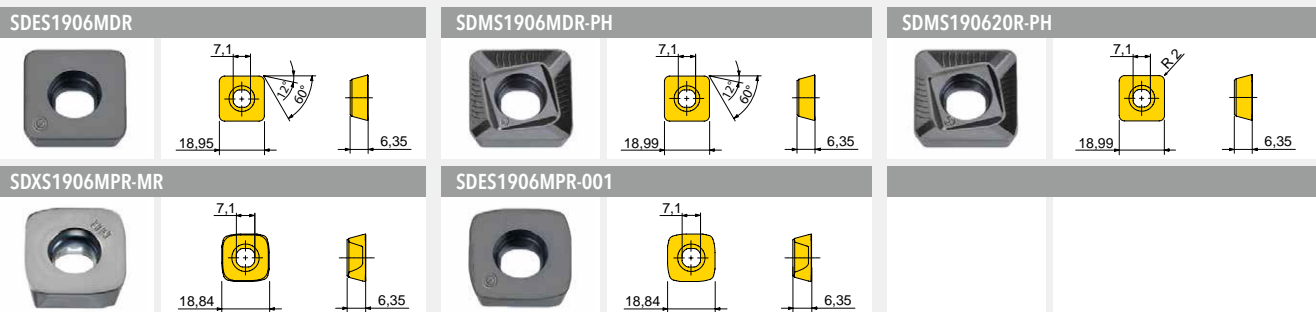

Artikel-Nr. Designation	fz(min/max)	Ausführung Design	Qualität Grade	IN2505	IN4005	IN4030	IN4035				
SDES1906MDR	**	neutrale Geometrie, gefast / neutral geometry, chamfered	●								
SDMS1906MDR-PH	**	positive Geometrie, gefast / positive geometry, chamfered	●●								
SDMS190620R-PH	**	positive Geometrie, gefast R2 / positive geometry, chamfered R2	●●								
SDXS1906MPR-MR	**	neutrale Geometrie, konvex, gefast / neutral geometry convex, chamfered	●●●								
SDES1906MPR-001	**	neutrale Geometrie, konvex, scharf / neutral geometry convex, sharp	●●●								

● = P ● = M ● = K ● = N ● = S ○ = H



SM60-135-R0 (8,0Nm) DS-T25S

① = Spannschraube / Insert screw ② = Schraubendreher / Screw driver

MIT EINSCHRAUBANSCHLUSS
SCREW-IN TYPE ADAPTION

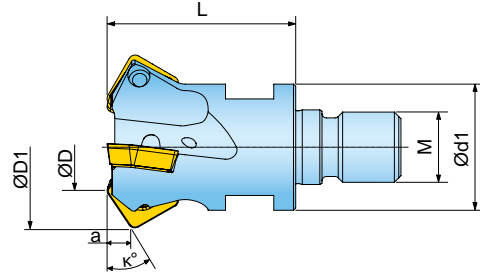
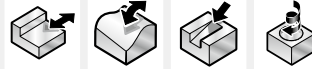

Artikel-Nr. Designation	D	D1	d1	L	κ	a	M	Z		
15M1P040043X8R30	20,1	40	29	43	30	4,9	M16	3	✓	0,18
15M1P042043X8R30	22,1	42	29	43	30	4,9	M16	3	✓	0,18

* fz-Werte / Programmerradien siehe Handbuch Schnittwerte für Fräs- und Bohrwerkzeuge / * fz-values see manual „Cutting Data for Milling & Boring Tools“

SDES1305MPR 	SDES1305MPR-001 	SDES130516N-PF
SDES130516N-PF1 	SDMS130516R-PP 	SDXS1305MPR-MR
SDXS130515R-PH 	SDXS130515N-HR 	

Artikel-Nr. Designation	fz(min/max)	Ausführung Design	Qualität Grade	IN2035	IN2505	IN4005	IN4030	IN4035			
SDES1305MPR	*/*	neutrale Geometrie, konvex, gefast / neutral geometry convex, chamfered									
SDES1305MPR-001	*/*	neutrale Geometrie, konvex, scharf / neutral geometry convex, sharp									
SDES130516N-PF	*/*	neutrale Geometrie, gefast R1,6 / neutral geometry, K-land R1,6									
SDES130516N-PF1	*/*	neutrale Geometrie, scharf R1,6 / neutral geometry, sharp R1,6									
SDMS130516R-PP	*/*	positive Geometrie, scharf R1,6 / positive geometry, sharp R1,6									
SDXS1305MPR-MR	*/*	neutrale Geometrie, konvex, gefast / neutral geometry convex, chamfered									
SDXS130515R-PH	*/*	positive Geometrie, gefast R1,5 / positive geometry, chamfered R1,5									
SDXS130515N-HR	*/*	positive Titan-Geometrie, gefast R1,5 / positive titanium geometry R1,5, K-land									

● = P ● = M ● = K ● = N ● = S ○ = H

ZUBEHÖR
SPARE PARTS



SM40-100-R0 (4,5Nm) DS-A00T

① = Spannschraube / Insert screw ② = Schraubendreher / Screw driver

AUFNAHME NACH DIN 8030
ADAPTION ACC. TO DIN 8030

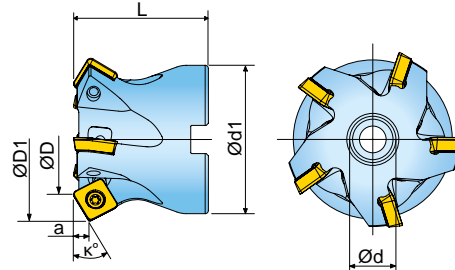
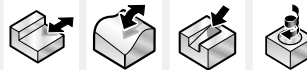

Artikel-Nr. Designation	D	D1	d	d1	L	κ	a	Z		
5M6P050R30	30,1	50	22	45	50	30	4,9	4	✓	0,30
5M5P050R30 ¹⁾	30,1	50	22	45	50	30	4,9	5	✓	0,30
5M6P063R30	43,1	63	22	55	50	30	4,9	5	✓	0,50
5M5P063R30 ¹⁾	43,1	63	22	55	50	30	4,9	6	✓	0,50
5M6P080R30	60,1	80	27	70	50	30	4,9	6	✓	1,00
5M5P080R30 ¹⁾	60,1	80	27	70	50	30	4,9	7	✓	1,00
5M6P100R30	80,1	100	32	85	55	30	4,9	7	✓	1,80
5M5P100R30 ¹⁾	80,1	100	32	85	55	30	4,9	9	✓	1,80

* fz-Werte / Programmerradien siehe Handbuch Schnittwerte für Fräs- und Bohrwerkzeuge / * fz-values see manual „Cutting Data for Milling & Boring Tools“

¹⁾ enge Teilung (nur für kurzspanende Werkstoffe) / Narrow spacing (only for short chip producing materials)

SDES1305MPR			SDES1305MPR-001			SDES130516N-PF		
SDES130516N-PF1			SDMS130516R-PP			SDXS1305MPR-MR		
SDXS130515R-PH			SDXS130515N-HR					

Artikel-Nr. Designation	fz(min/max)	Ausführung Design	Qualität Grade	IN2035	IN2505	IN4005	IN4030	IN4035			
SDES1305MPR	*/*	neutrale Geometrie, konvex, gefast / neutral geometry convex, chamfered									
SDES1305MPR-001	*/*	neutrale Geometrie, konvex, scharf / neutral geometry convex, sharp									
SDES130516N-PF	*/*	neutrale Geometrie, gefast R1,6 / neutral geometry, K-land R1,6									
SDES130516N-PF1	*/*	neutrale Geometrie, scharf R1,6 / neutral geometry, sharp R1,6									
SDMS130516R-PP	*/*	positive Geometrie, scharf R1,6 / positive geometry, sharp R1,6									
SDXS1305MPR-MR	*/*	neutrale Geometrie, konvex, gefast / neutral geometry convex, chamfered									
SDXS130515R-PH	*/*	positive Geometrie, gefast R1,5 / positive geometry, chamfered R1,5									
SDXS130515N-HR	*/*	positive Titan-Geometrie, gefast R1,5 / positive titanium geometry R1,5, K-land									

● = P ● = M ● = K ● = N ● = S ○ = H

ZUBEHÖR
SPARE PARTS

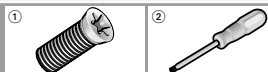

SM40-100-R0 (4,5Nm) DS-A00T

① = Spannschraube / Insert screw ② = Schraubendreher / Screw driver

AUFNAHME NACH DIN 8030
ADAPTION ACC. TO DIN 8030

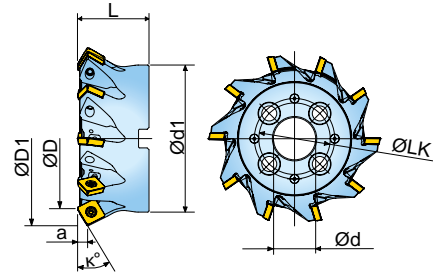
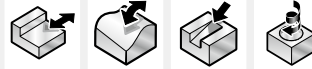

Artikel-Nr. Designation	D	D1	d	d1	LK	L	κ	a	Z		
5G5M080R30	51,7	80	27	70	-	55	30	7,8	6	✓	0,90
5G5M100R30	71,7	100	32	85	-	55	30	7,8	7	✓	1,50
5G5M125R30	96,7	125	40	100	-	63	30	7,8	8	✓	2,70
5G5M160R30	131,7	160	40	130	66,7	63	30	7,8	10	✓	4,40

* fz-Werte / Programmerradien siehe Handbuch Schnittwerte für Fräs- und Bohrwerkzeuge / * fz-values see manual „Cutting Data for Milling & Boring Tools“

SDES1906MPR-001 	SDES1906ZPR-PF 	SDMS1906ZPR-PP
SDES190620N 	SDMS190620R-PH 	SDES190620N-001
SDXS1906MPR-MR 		

Artikel-Nr. Designation	fz(min/max)	Ausführung Design	Qualität Grade	IN2505	IN4005	IN4030	IN4035				
SDES1906MPR-001	*/*	neutrale Geometrie, konvex, scharf / neutral geometry convex, sharp									
SDES1906ZPR-PF	*/*	neutrale Geometrie, gefast mit Wiper / neutral wiper geometry with K-land									
SDMS1906ZPR-PP	*/*	positive Geometrie mit Wiper / positive wiper geometry									
SDES190620N	*/*	neutrale Geometrie, gefast R2 / neutral geometry, chamfered R2									
SDMS190620R-PH	*/*	positive Geometrie, gefast R2 / positive geometry, chamfered R2									
SDES190620N-001	*/*	neutrale Geometrie, scharf R2 / neutral geometry, sharp R2									
SDXS1906MPR-MR	*/*	neutrale Geometrie, konvex, gefast / neutral geometry convex, chamfered									

● = P ● = M ● = K ● = N ● = S ○ = H

ZUBEHÖR
SPARE PARTS

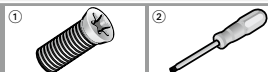

SM60-135-R0 (8,0Nm) DS-T25S





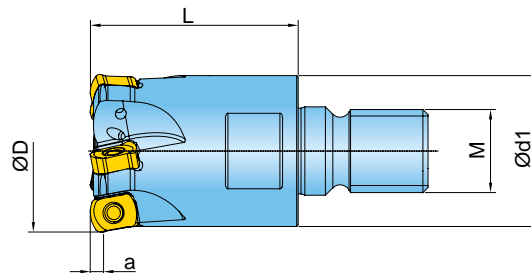





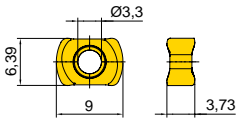

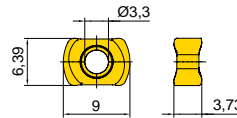

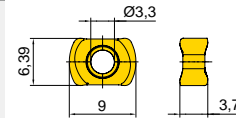

① = Spannschraube / Insert screw ② = Schraubendreher / Screw driver

MIT EINSCHRAUBANSCHLUSS
 SCREW-IN TYPE ADAPTION



Artikel-Nr. Designation	D	d1	L	a	M	Z			
1TG1F016025X5R00	16	13	25	1	M8	2	2	✓	0,03
1TG1F020030X6R00	20	18	30	1	M10	3	1,8	✓	0,05
1TG1F025035X7R00	25	21	35	1	M12	4	1,3	✓	0,09
1TG1F030043X8R00	30	29	43	1	M16	5	1	✓	0,21
1TG1F032040X8R00	32	29	40	1	M16	5	1	✓	0,21
1TG1F032040X8R01	32	29	40	1	M16	6	1	✓	0,21
1TG1F035043X8R00	35	29	43	1	M16	5	0,8	✓	0,24
1TG1F035043X8R01	35	29	43	1	M16	4	0,8	✓	0,24
1TG1F042043X8R00	42	29	43	1	M16	6	0,7	✓	0,28
1TG1F042043X8R01	42	29	43	1	M16	5	0,7	✓	0,28

Programmier-Radius R2 / Programming radius 2mm

UNLU0603MOTR		UNLU0603MOTR-MM		UNLU0603MOTR-ML							
											
Artikel-Nr. Designation	fz(min/max)	Ausführung Design	Qualität Grade	IN2035	IN2504	IN2505	IN2530	IN7035			
UNLU0603MOTR	0,50/1,20	semi-positive Geometrie / semi positive geometry									
UNLU0603MOTR-MM	0,50/1,00	positive Geometrie / positive geometry									
UNLU0603MOTR-ML	0,40/0,80	Inconel- und Titangeometrie / Inconel - titanium geometry									

● = P ● = M ● = K ● = N ● = S ○ = H

ZUBEHÖR
SPARE PARTS



SM25-064-00 (1,1Nm) DS-T08S

① = Spannschraube / Insert screw ② = Schraubendreher / Screw driver

MODULARE INNOFIT AUFNAHME
 MODULAR MILLING ADAPTOR INNOFIT

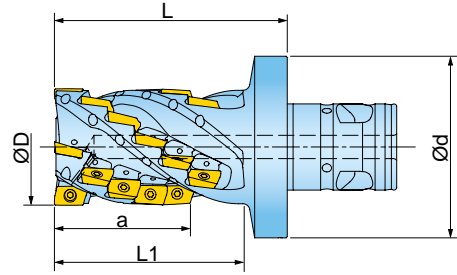
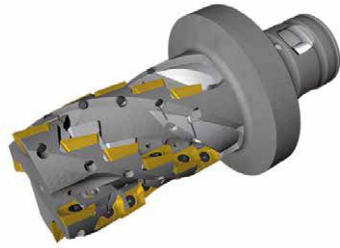

Artikel-Nr.
 Designation

D d L L1 a MOD Z Zeff



Artikel-Nr. Designation	D	d	L	L1	a	MOD	Z	Zeff			
22J3R032046Z4R00	32	49	75	56	46	40	8	2	5,0	✓	0,50
22J3R032046Z5R00	32	78	75	55	46	50	8	2	5,0	✓	1,10
22J3R040058Z4R00	40	49	90	71	58	40	15	3	3,2	✓	0,72
22J3R040058Z5R00	40	78	90	71	58	50	15	3	3,2	✓	1,30
22J3R050069Z5R01	50	78	100	82	69	50	24	4	2,1	✓	1,60
22J3R063081Z5R00	63	78	110	93	81	50	35	5	1,4	✓	2,33

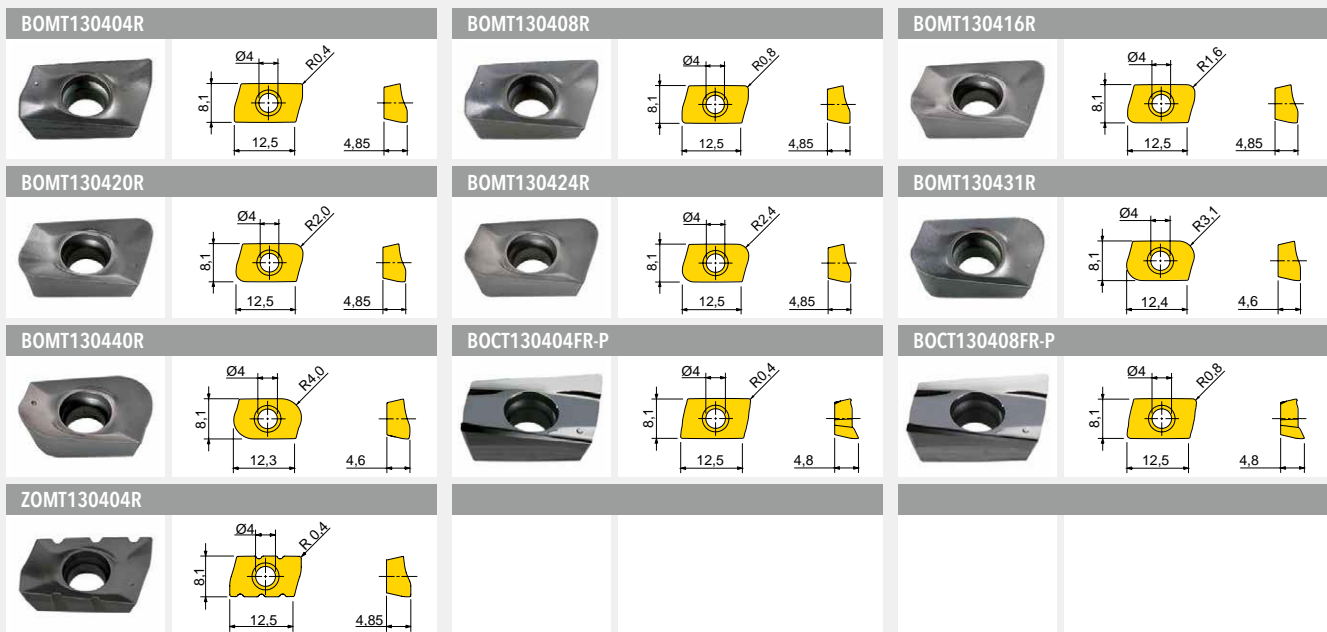

Artikel-Nr. Designation	fz(min/max)	Ausführung Design	Qualität Grade	IN10K	IN2035	IN2504	IN2505	IN2530	IN4030
BOMT130404R	0,12/0,20	positive Geometrie R0,4 / positive geometry R0,4							
BOMT130408R	0,12/0,20	positive Geometrie R0,8 / positive geometry R0,8							
BOMT130416R	0,12/0,20	positive Geometrie R1,6 / positive geometry R1,6							
BOMT130420R	0,12/0,20	positive Geometrie R2,0 / positive geometry R2,0							
BOMT130424R ¹⁾	0,12/0,20	positive Geometrie R2,4 / positive geometry R2,4							
BOMT130431R ¹⁾	0,12/0,20	positive Geometrie R3,1 / positive geometry R3,1							
BOMT130440R ¹⁾	0,12/0,20	positive Geometrie R4,0 / positive geometry R4,0							
BOCT130404FR-P	0,05/0,25	NE-Geometrie, poliert R0,4 / non-ferrous geometry, polished R0,4							
BOCT130408FR-P	0,05/0,25	NE-Geometrie, poliert R0,8 / non-ferrous geometry, polished R0,8							
ZOMT130404R ²⁾	0,12/0,20	positive Spanbrecher-Geometrie R0,4 / chip splitter geometry R0,4							

¹⁾Fräskörper nachdrehen / Cutter body has to be modified; ²⁾ Optimale Ergebnisse erzielen Sie auf Werkzeugen mit gerader Zähnezahl. Bitte wechselseitig montieren. / Best results are achieved on tools with an even number of teeth. Please mount inserts alternating.

= P = M = K = N = S = H

ZUBEHÖR
SPARE PARTS

SM35-088-10 (3,0Nm) DS-T10S

① = Spannschraube / Insert screw ② = Schraubendreher / Screw driver

MODULARE INNOFIT AUFNAHME
MODULAR MILLING ADAPTOR INNOFIT

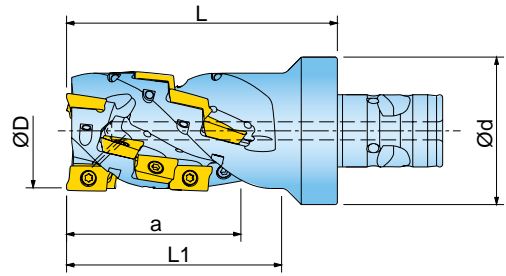

Artikel-Nr. Designation	D	d	L	L1	a	MOD	Z	Zeff			
22J3X032047Z4R00	32	49	75	56	46,5	40	8	2	5,1	✓	0,47
22J3X032047Z5R00	32	78	75	55	46,5	50	8	2	5,1	✓	1,06
22J3X040058Z4R00	40	49	90	72	57,5	40	15	3	3,7	✓	0,69
22J3X040058Z5R00	40	78	90	71	57,5	50	15	3	3,7	✓	1,25
22J3X050069Z5R00	50	78	100	82	69	50	24	4	2,8	✓	1,55
22J3X063081Z5R00	63	78	110	93	80,5	50	35	5	2,1	✓	2,28
22J3X080081Z5R00	80	78	110	110	80,5	50	42	6	0,9	✓	3,43

Artikel-Nr. Designation	fz(min/max)	Ausführung Design	Qualität Grade	IN10K	IN2005	IN2010	IN2030	IN2505	IN2530	IN2540
AOMT120404R	0,12/0,20	positive Geometrie R0,4 / positive geometry R0,4			●					●
AOMT120408R	0,05/0,50	positive Geometrie R0,8 / positive geometry R0,8						●	●	
AOMT120416R	0,12/0,20	positive Geometrie R1,6 / positive geometry R1,6		●		●	●			
AOMT120424R ¹⁾	0,12/0,20	positive Geometrie R2,4 / positive geometry R2,4		●		●	●			
AOMT120432R ¹⁾	0,12/0,20	positive Geometrie R3,2 / positive geometry R3,2		●		●	●			
AOMT120440R ¹⁾	0,12/0,20	positive Geometrie R4,0 / positive geometry R4,0						●		
AOMT120408R-HS	0,07/0,20	positive Titan-Geometrie R0,8 / positive titanium geometry R0,8		●						
AOCT120408FR-P	0,05/0,20	NE-Geometrie, poliert R0,8 / non-ferrous geometry, polished R0,8	●							

¹⁾ Fräskörper nachdrehen / Cutter body has to be modified

● = P ● = M ● = K ● = N ● = S ○ = H

ZUBEHÖR
SPARE PARTS

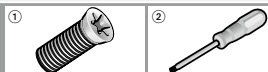

SM35-088-10 (3,0Nm) DS-T10S

① = Spannschraube / Insert screw ② = Schraubendreher / Screw driver

AUFNAHME NACH DIN 8030
ADAPTION ACC. TO DIN 8030

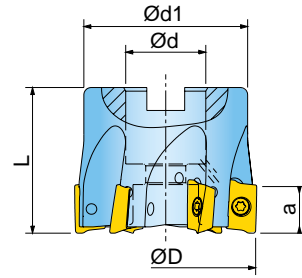

Artikel-Nr. Designation	D	d	d1	L	a	Z			
2J1X040R00	40	22	37	40	12	5	3,7	✓	0,16
2J1X050R00	50	22	45	40	12	6	2,8	✓	0,28
2J1X063R00	63	22	55	40	12	7	2,1	✓	0,51
2J1X080R00	80	27	70	50	12	8	1,6	✓	1,12

AOMT120404R 	AOMT120408R 	AOMT120416R
AOMT120424R 	AOMT120432R 	AOMT120440R
AOMT120408R-HS 	AOCT120408FR-P 	

Artikel-Nr. Designation	fz(min/max)	Ausführung Design	Qualität Grade	IN10K	IN2005	IN2010	IN2030	IN2505	IN2530	IN2540
AOMT120404R	0,12/0,20	positive Geometrie R0,4 / positive geometry R0,4								
AOMT120408R	0,05/0,50	positive Geometrie R0,8 / positive geometry R0,8								
AOMT120416R	0,12/0,20	positive Geometrie R1,6 / positive geometry R1,6								
AOMT120424R ¹⁾	0,12/0,20	positive Geometrie R2,4 / positive geometry R2,4								
AOMT120432R ¹⁾	0,12/0,20	positive Geometrie R3,2 / positive geometry R3,2								
AOMT120440R ¹⁾	0,12/0,20	positive Geometrie R4,0 / positive geometry R4,0								
AOMT120408R-HS	0,07/0,20	positive Titan-Geometrie R0,8 / positive titanium geometry R0,8								
AOCT120408FR-P	0,05/0,20	NE-Geometrie, poliert R0,8 / non-ferrous geometry, polished R0,8								

¹⁾Fräskörper nachdrehen / Cutter body has to be modified

= P = M = K = N = S = H

ZUBEHÖR
SPARE PARTS









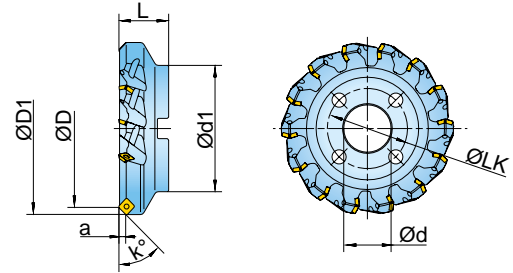
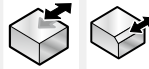



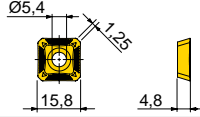

SM35-088-10 (3,0Nm) DS-T10S

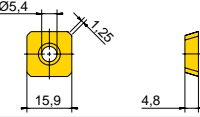
① = Spannschraube / Insert screw ② = Schraubendreher / Screw driver

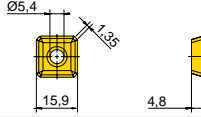
AUFNAHME NACH DIN 8030
ADAPTION ACC. TO DIN 8030



Artikel-Nr. Designation	D	D1	d	d1	LK	L	κ	a	Z		 kg
5N6R080R00	80	98,1	27	80	-	50	45	9	7	✓	1,52
5N6R100R00	100	118,1	32	90	-	55	45	9	8	✓	2,29
5N6R125R00	125	143,1	40	100	-	65	45	9	10	✓	4,21
5N6R160R00	160	178,1	40	130	-	65	45	9	12	✓	7,18
5N6R200R00	200	218,1	60	160	101,6	63	45	9	14		7,23
5N6R250R00	250	268,1	60	220	101,6	63	45	9	16		13,69
5N6R315R00	315	333,1	60	220	101,6	80	45	9	18		27,67

SHE1504AETN-HR		SHEW1504AJTN		SHEH1504AEN-P												
																
Artikel-Nr. Designation	fz(min/max)	Ausführung Design	Qualität Grade	IN05S	IN2035	IN4005	IN4030	IN6535								
SHE1504AETN-HR	0,25/0,35	hoch-positive Geometrie / high positive geometry														
SHEW1504AJTN	0,20/0,50	neutrale Geometrie / neutral geometry														
SHEH1504AEN-P	0,05/0,30	positive Alugeometrie / positive aluminum geometry														

● = P ● = M ● = K ● = N ● = S ○ = H

ZUBEHÖR / SPARE PARTS

① 

② 

SM50-120-10 (6,0Nm) DS-T20S

① = Spannschraube / Insert screw ② = Schraubendreher / Screw driver

AUFNAHME NACH DIN 8030
 ADAPTION ACC. TO DIN 8030

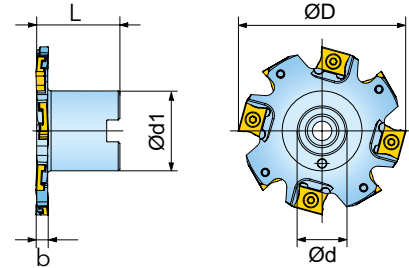

Artikel-Nr. Designation	D	d	d1	L	b	Z	Zeff	 kg	Passende WSP Related Insert
3VJ5V063003F0R00	63	16	30	32	3	8	4	0,16	AB
3VJ5V063004F0R00	63	16	30	32	4	8	4	0,19	CDEFG
3VJ5V063005F0R00	63	16	30	32	5	8	4	0,21	HJKLM
3VJ5V063006F0R00	63	16	30	32	6	6	3	0,22	MNOPQR
3VJ5V080003F1R00	80	22	38	40	3	10	5	0,32	AB
3VJ5V080004F1R00	80	22	38	40	4	10	5	0,36	CDEFG
3VJ5V080005F1R00	80	22	38	40	5	10	5	0,38	HJKLM
3VJ5V080006F1R00	80	22	38	40	6	8	4	0,40	MNOPQR
3VJ5V100003F2R00	100	27	45	45	3	14	7	0,52	AB
3VJ5V100004F2R00	100	27	45	45	4	12	6	0,56	CDEFG
3VJ5V100005F2R00	100	27	45	45	5	12	6	0,60	HJKLM
3VJ5V100006F2R00	100	27	45	45	6	10	5	0,62	MNOPQR
3VJ5V125004F3R00	125	32	58	50	4	14	7	1,04	CDEFG
3VJ5V125005F3R00	125	32	58	50	5	14	7	1,10	HJKLM
3VJ5V125006F3R00	125	32	58	50	6	12	6	1,14	MNOPQR
3VJ5V160004F4R00	160	40	70	60	4	18	9	1,83	CDEFG
3VJ5V160005F4R00	160	40	70	60	5	18	9	1,93	HJKLM
3VJ5V160006F4R00	160	40	70	60	6	16	8	2,00	MNOPQR

ZUBEHÖR
 SPARE PARTS

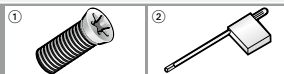

Schnittbreite / Cutting Width

3	SM25-024-80 (0,7Nm) DS-T06F
4	SM35-034-50 (1,4Nm) DS-T09S
5	SM35-042-50 (1,4Nm) DS-T09S
6	SM40-050-50 (4,5Nm) DS-T15S

① = Spannschraube / Insert screw ② = Schraubendreher / Screw driver



Artikel-Nr. Designation	fz(min/max)	Ausführung Design	Qualität Grade	IN05S	IN2505	IN2515	IN2530	IN4035				
IEE211-001	0,05/0,12	positive Geometrie R0,4 / positive geometry R0,4			●		●	●				
IEE211-001-P	0,05/0,12	NE-Geometrie, poliert R0,4 / non-ferrous geometry, polished R0,4	●									
IEE311-001	0,05/0,12	positive Geometrie R0,4 / positive geometry R0,4			●	●	●	●				
IEE311-001-P	0,05/0,12	NE-Geometrie, poliert R0,4 / non-ferrous geometry, polished R0,4	●									
IEE311-002	0,05/0,15	positive Geometrie R0,8 / positive geometry R0,8			●		●	●				
IEE311-002-P	0,05/0,15	NE-Geometrie, poliert R0,8 / non-ferrous geometry, polished R0,8	●									
IEE311-004	0,05/0,15	positive Geometrie 0,15x20° / positive geometry 0,15x20°			●		●					
IEE312-001	0,05/0,17	positive Geometrie R0,4 / positive geometry R0,4			●	●	●	●				
IEE312-001-P	0,05/0,17	NE-Geometrie, poliert R0,4 / non-ferrous geometry, polished R0,4	●									
IEE312-002	0,05/0,17	positive Geometrie R0,8 / positive geometry R0,8			●	●	●	●				
IEE312-002-P	0,05/0,17	NE-Geometrie, poliert R0,8 / non-ferrous geometry, polished R0,8	●									
IEE312-004	0,05/0,17	positive Geometrie 0,15x20° / positive geometry 0,15x20°			●		●					
IXE412-001	0,05/0,20	positive Geometrie R0,4 / positive geometry R0,4			●	●	●	●				
IXE412-001-P	0,05/0,20	NE-Geometrie, poliert R0,4 / non-ferrous geometry, polished R0,4	●									
IXE412-002	0,05/0,20	positive Geometrie R0,8 / positive geometry R0,8			●	●	●	●				
IXE412-002-P	0,05/0,20	NE-Geometrie, poliert R0,8 / non-ferrous geometry, polished R0,8	●									
IXE412-003	0,05/0,20	positive Geometrie R1,6 / positive geometry R1,6			●		●					
IXE412-004	0,05/0,20	positive Geometrie 0,3x17° / positive geometry 0,3x17°			●		●					

● = P ● = M ● = K ● = N ● = S ○ = H

AUFNAHME NACH DIN 8030
 ADAPTION ACC. TO DIN 8030

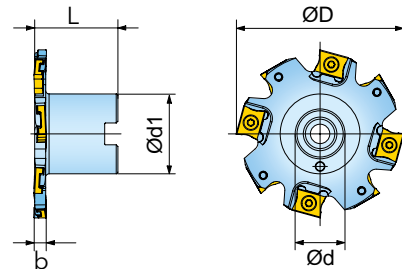

Artikel-Nr. Designation	D	d	d1	L	b	Z	Z _{eff}	 kg	Passende WSP Related Insert
3VJ5V063007F0R00	63	16	30	32	7	6	3	0,23	ABCDEF
3VJ5V063008F0R00	63	16	30	32	8	6	3	0,24	ABCDEF
3VJ5V063009F0R00	63	16	30	32	9	6	3	0,26	GHIJKL
3VJ5V063010F0R00	63	16	30	32	10	6	3	0,27	GHIJKL
3VJ5V080007F1R00	80	22	38	40	7	8	4	0,42	ABCDEF
3VJ5V080008F1R00	80	22	38	40	8	8	4	0,45	ABCDEF
3VJ5V080009F1R00	80	22	38	40	9	8	4	0,48	GHIJKL
3VJ5V080010F1R00	80	22	38	40	10	8	4	0,50	GHIJKL
3VJ5V100007F2R00	100	27	45	45	7	10	5	0,66	ABCDEF
3VJ5V100008F2R00	100	27	45	45	8	10	5	0,70	ABCDEF
3VJ5V100009F2R00	100	27	45	45	9	10	5	0,72	GHIJKL
3VJ5V100010F2R00	100	27	45	45	10	10	5	0,76	GHIJKL
3VJ5V125007F3R00	125	32	58	50	7	12	6	1,20	ABCDEF
3VJ5V125008F3R00	125	32	58	50	8	12	6	1,26	ABCDEF
3VJ5V125009F3R00	125	32	58	50	9	12	6	1,29	GHIJKL
3VJ5V125010F3R00	125	32	58	50	10	12	6	1,35	GHIJKL
3VJ5V160007F4R00	160	40	70	60	7	16	8	2,10	ABCDEF
3VJ5V160008F4R00	160	40	70	60	8	16	8	2,21	ABCDEF
3VJ5V160009F4R00	160	40	70	60	9	16	8	2,27	GHIJKL
3VJ5V160010F4R00	160	40	70	60	10	16	8	2,38	GHIJKL

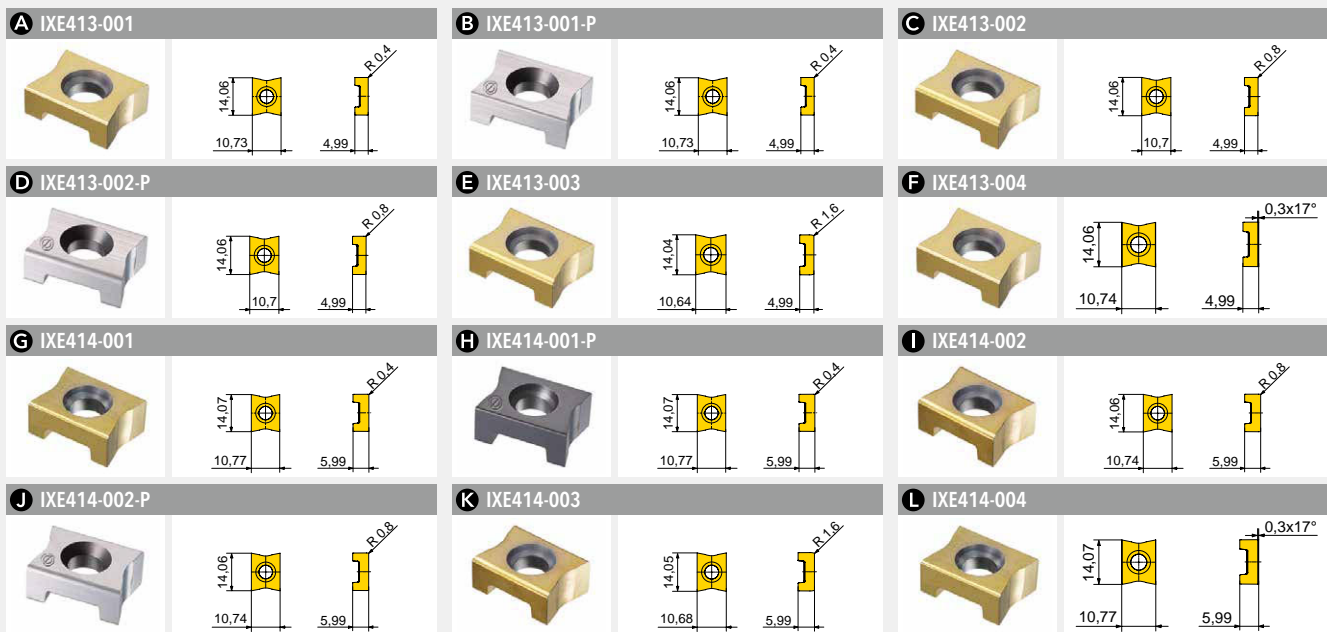

Artikel-Nr. Designation	fz(min/max)	Ausführung Design	Qualität Grade	IN05S	IN250S	IN251S	IN2530	IN4035			
IXE413-001	0,05/0,20	positive Geometrie R0,4 / positive geometry R0,4			●	●	●	●			
IXE413-001-P	0,05/0,20	NE-Geometrie, poliert R0,4 / non-ferrous geometry, polished R0,4	●								
IXE413-002	0,05/0,20	positive Geometrie R0,8 / positive geometry R0,8			●	●	●	●			
IXE413-002-P	0,05/0,20	NE-Geometrie, poliert R0,8 / non-ferrous geometry, polished R0,8	●								
IXE413-003	0,05/0,20	positive Geometrie R1,6 / positive geometry R1,6			●		●				
IXE413-004	0,05/0,20	positive Geometrie 0,3x17° / positive geometry 0,3x17°			●		●				
IXE414-001	0,05/0,25	positive Geometrie R0,4 / positive geometry R0,4			●	●	●	●			
IXE414-001-P	0,05/0,25	NE-Geometrie, poliert R0,4 / non-ferrous geometry, polished R0,4	●								
IXE414-002	0,05/0,25	positive Geometrie R0,8 / positive geometry R0,8			●	●	●	●			
IXE414-002-P	0,05/0,25	NE-Geometrie, poliert R0,8 / non-ferrous geometry, polished R0,8	●								
IXE414-003	0,05/0,25	positive Geometrie R1,6 / positive geometry R1,6			●		●				
IXE414-004	0,05/0,25	positive Geometrie 0,3x17° / positive geometry 0,3x17°			●		●				

● = P ● = M ● = K ● = N ● = S ○ = H

ZUBEHÖR
SPARE PARTS



Schnittbreite / Cutting Width

7	SM40-060-50 (4,5Nm) DS-T15S
8	SM40-070-50 (4,5Nm) DS-T15S
9 - 10	SM40-080-50 (4,5Nm) DS-T15S

① = Spannschraube / Insert screw ② = Schraubendreher / Screw driver

MIT EINSCHRAUBANSCHLUSS
 SCREW-IN TYPE ADAPTION

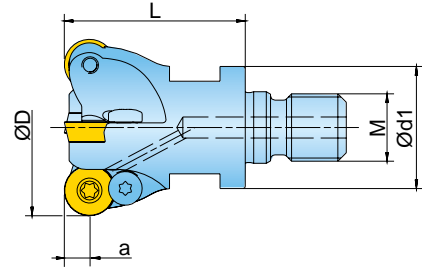
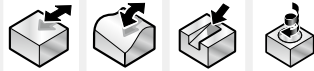

Artikel-Nr. Designation	D	d1	L	a	M	Z	WSP Ø		
15B1H024035X7R00	24	21	35	6	M12	2	12	3,5	✓
15B1H032043X8R00	32	29	43	6	M16	3	12	2	✓
15B1H035043X8R00	35	29	43	6	M16	3	12	2	✓
15B1H042043X8R00	42	29	43	6	M16	4	12	2	✓

Neutrale Ausführung / Neutral design

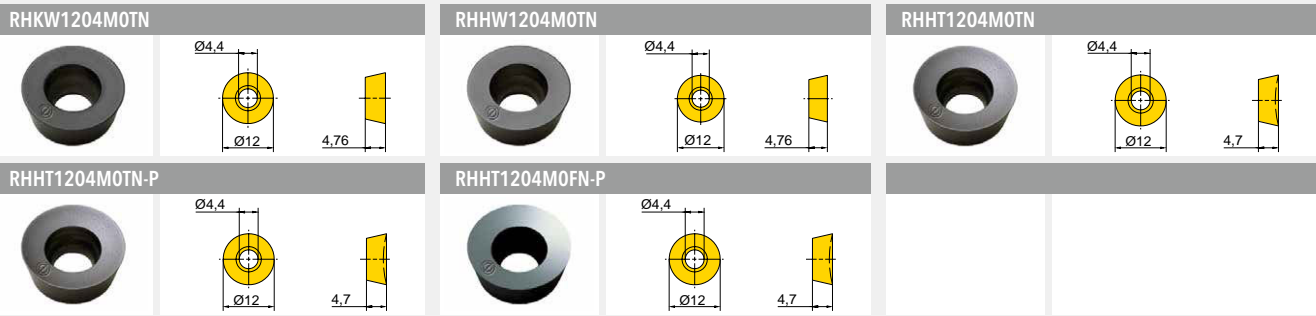

Artikel-Nr. Designation	fz(min/max)	Ausführung Design	Qualität Grade	IN05S	IN2004	IN2005	IN2006	IN2035	IN2505	IN4015	IN7035
RHKW1204M0TN	0,25/0,80	neutrale Schruppgeometrie / neutral roughing geometry									
RHHW1204M0TN	0,25/0,60	neutrale Geometrie, gefast / neutral geometry, K-land									
RHHT1204M0TN	0,25/0,50	positive Geometrie, gefast / positive geometry, K-land									
RHHT1204M0TN-P	0,10/0,25	Titan-Geometrie, poliert / titanium geometry, polished									
RHHT1204M0FN-P	0,15/0,30	NE-Geometrie, poliert / non-ferrous geometry, polished									

● = P ● = M ● = K ● = N ● = S ○ = H

ZUBEHÖR SPARE PARTS			
	SM40-080-10 (4,5Nm)	DS-T15S	SF035-01 (2,0Nm)

① = Spannschraube / Insert screw ② = Schraubendreher / Screw driver ③ = Klemmschraube / Clamping screw

AUFNAHME NACH DIN 8030
 ADAPTION ACC. TO DIN 8030

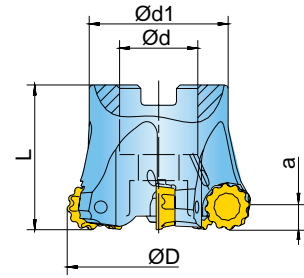
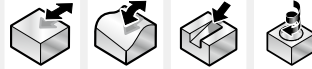

Artikel-Nr. Designation	D	d	d1	L	a	Z			
5E6K050R00	50	22	40	50	8	4	7,6	✓	0,36
5E6K052R00	52	22	40	50	8	4	7,8	✓	0,36
5E6K063R00	63	27	48	50	8	5	6,1	✓	0,56
5E6K066R00	66	27	48	50	8	5	5,8	✓	0,56
5E6K080R00	80	27	60	50	8	6	4,2	✓	1,00
5E6K100R00	100	32	70	55	8	7	3		1,38
5E6K125R00	125	40	90	55	8	8	2,3		2,44
5E6K160R00	160	40	120	55	8	9	2		4,67

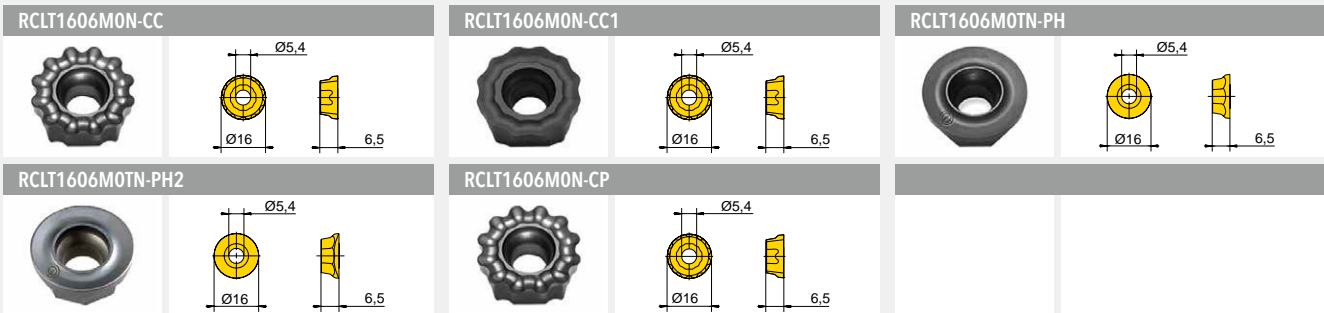

Artikel-Nr. Designation	fz(min/max)	Ausführung Design	Qualität Grade	IN05S	IN2005	IN4015	IN4030	IN4040			
RCLT1606MON-CC	0,10/0,25	positive Stahlgeometrie R1,2 / positive steel geometry R1,2									
RCLT1606MON-CC1	0,10/0,30	positive Stahlgeometrie R1,6 / positive steel geometry R1,6									
RCLT1606MOTN-PH	0,10/0,50	positive Stahlgeometrie / positive steel geometry									
RCLT1606MOTN-PH2	0,20/0,80	positive Geometrie, neg. gefast / positive geometry, neg. K-land									
RCLT1606MON-CP	0,10/0,25	positive Alugeometrie / positive non-ferrous geometry									

● = P ● = M ● = K ● = N ● = S ○ = H

ZUBEHÖR
 SPARE PARTS

① ②

SM50-120-10 (6,0Nm) DS-T20T

① = Spannschraube / Insert screw ② = Schraubendreher / Screw driver

AUFNAHME NACH DIN 8030
 ADAPTION ACC. TO DIN 8030

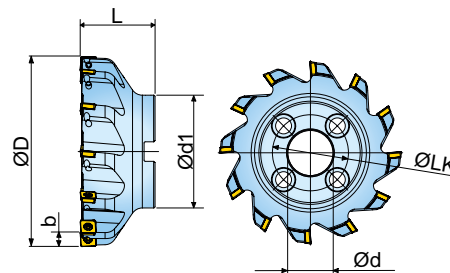

Artikel-Nr. Designation	D	d	d1	LK	L	b	Z	Ⓚ	kg
QHU050040F1R00	50	22	40	-	40	11,9	4	✓	0,40
QHU052040F1R00	52	22	40	-	40	11,9	4	✓	0,45
QHU066050F2R00	66	27	48	-	50	11,9	5	✓	0,70
QHU080050F2R00	80	27	60	-	50	11,9	6	✓	1,10
QHU085050F2R00	85	27	60	-	50	11,9	6	✓	1,25
QHU100050F3R00	100	32	70	-	50	11,9	8	✓	1,80
QHU125063E5R00	125	40	80	-	63	11,9	9		2,60
QHU160063F8R00	160	40	95	66,7	63	11,9	12		4,00

* fz-Werte siehe Handbuch Schnittwerte für Fräs- und Bohrwerkzeuge / * fz-values see manual „Cutting Data for Milling & Boring Tools“

SDES130508N-PF

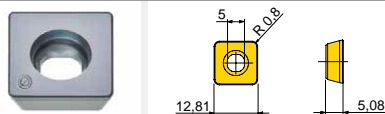

SDES130508N-PF1

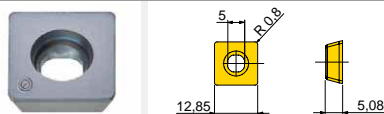

SDES130516N-PF

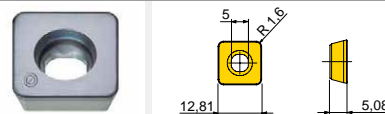

SDES130516N-PF1

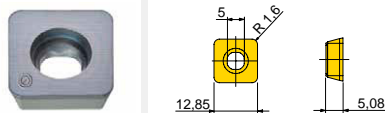

SDMS130512R-PP

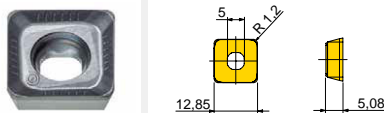

SDMS130516R-PP

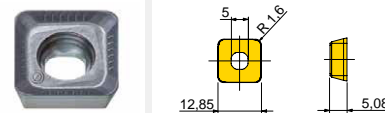

Artikel-Nr. Designation	fz(min/max)	Ausführung Design	Qualität Grade	IN2505	IN4005	IN4015	IN4030	IN4035			
SDES130508N-PF	*/*	neutrale Geometrie, gefast R0,8 / neutral geometry, K-land R0,8		●	●	●	●	●			
SDES130508N-PF1	*/*	neutrale Titan-Geometrie, scharf R0,8 / neutral titanium geometry R0,8					●	●			
SDES130516N-PF	*/*	neutrale Geometrie, gefast R1,6 / neutral geometry, K-land R1,6		●	●						
SDES130516N-PF1	*/*	neutrale Geometrie, scharf R1,6 / neutral geometry, sharp R1,6					●	●			
SDMS130512R-PP	*/*	positive Geometrie, scharf R1,2 / positive geometry, sharp R1,2					●	●			
SDMS130516R-PP	*/*	positive Geometrie, scharf R1,6 / positive geometry, sharp R1,6			●		●	●			

● = P ● = M ● = K ● = N ● = S ○ = H

ZUBEHÖR
 SPARE PARTS

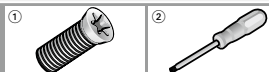

SM40-100-R0 (4,5Nm) DS-A00T

① = Spannschraube / Insert screw ② = Schraubendreher / Screw driver

AUFNAHME NACH DIN 6535 HA
 ADAPTION ACC. TO DIN 6535 HA

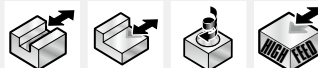

Spezielle Schruppgeometrie in kordelverzahnter Ausführung für die Aluminiumbearbeitung mit IK.
 Special serrated roughing geometry for aluminum machining with internal coolant supply.

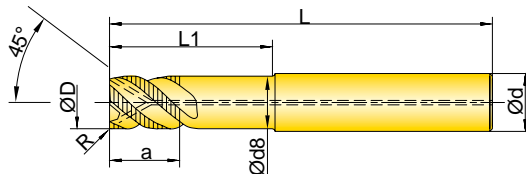

Qualität Grade	P	M	K	N _(K)	S _(M)	H _(PK)		D	e8		
IN1205				+			R	± 0.05			
							d	h6			

+ Gut geeignet / Preferred choice ○ Bedingt geeignet / Second choice ▼ Schruppen / Roughing ▼▼ Vorschlichten / Pre-finishing ▼▼▼ Schlichten / Finishing

Artikel-Nr. Designation	D	d	d8	L	L1	a	R	Z	IK	kg
INNOV080.020.041Z3CCB	8	8	7,5	83	41	12	0,2	3	✓	
INNOV080.200.041Z3CCB	8	8	7,5	83	41	12	2	3	✓	
INNOV100.020.041Z3CCB	10	10	9,1	83	41	12	0,2	3	✓	
INNOV100.200.041Z3CCB	10	10	9,1	83	41	12	2	3	✓	
INNOV120.020.041Z3CCB	12	12	11	87	41	12	0,2	3	✓	
INNOV120.200.041Z3CCB	12	12	11	87	41	12	2	3	✓	
INNOV120.400.041Z3CCB	12	12	11	87	41	12	4	3	✓	
INNOV160.200.047Z3CCB	16	16	15	97	47	14	2	3	✓	
INNOV160.020.060Z3CCB	16	16	15	109	60	14	0,2	3	✓	
INNOV160.200.060Z3CCB	16	16	15	109	60	14	2	3	✓	
INNOV160.400.060Z3CCB	16	16	15	109	60	14	4	3	✓	0,290
INNOV200.020.060Z3CCB	20	20	18,8	111	60	17	0,2	3	✓	
INNOV200.200.060Z3CCB	20	20	18,8	111	60	17	2	3	✓	
INNOV200.400.060Z3CCB	20	20	18,8	111	60	17	4	3	✓	
INNOV200.400.100Z3CCB	20	20	18,8	150	100	30	4	3	✓	

Werkzeuge in Ausführung DIN 6535 B, nicht aufgeführte Radien und Werkzeuglängen auf Anfrage.
 Shaft version in DIN6535 B, different corner radii and tool lengths on request!

AUFNAHME NACH DIN 6535 HA
ADAPTION ACC. TO DIN 6535 HA

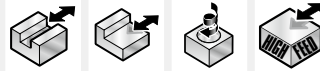

Spezielle HPC Geometrie für die Aluminiumbearbeitung zum Schruppen und Schlichten. Ungleich geteilt mit IK, freigeschliffene Werkzeuggeometrie.
Special HPC geometry for roughing and finishing of aluminum. Irregular pitch with internal coolant, reduced shaft diameter.

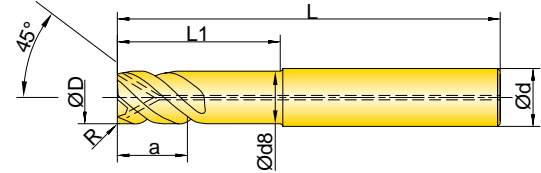

Qualität Grade	P	M	K	N _(K)	S _(M)	H _(PK)		D	h6		
IN05S				+			R	± 0.05			
							d	h6			

+ Gut geeignet / Preferred choice ○ Bedingt geeignet / Second choice ▼ Schruppen / Roughing ▼▼ Vorschlichten / Pre-finishing ▼▼▼ Schlichten / Finishing

Artikel-Nr. Designation	D	d	d8	L	L1	a	R	Z	IK	kg
INNOV080.020.040Z3C	8	8	7,5	79	40	12	0,2	3	✓	
INNOV080.200.041Z3C	8	8	7,5	79	41	12	2	3	✓	
INNOV100.020.041Z3C	10	10	9,1	83	41	15	0,2	3	✓	
INNOV100.200.041Z3C	10	10	9,1	83	41	15	2	3	✓	0,085
INNOV120.020.041Z3C	12	12	11,0	88	41	18	0,2	3	✓	
INNOV120.200.041Z3C	12	12	11,0	88	41	18	2	3	✓	
INNOV120.400.041Z3C	12	12	11,0	88	41	18	4	3	✓	
INNOV160.050.060Z3C	16	16	15,0	109	60	40	0,5	3	✓	
INNOV160.200.060Z3C	16	16	15,0	109	60	40	2	3	✓	
INNOV160.400.060Z3C	16	16	15,0	109	60	40	4	3	✓	0,300
INNOV160.200.065Z3C	16	16	15,0	114	65	24	2	3	✓	
INNOV160.200.080Z3C	16	16	15,0	128	80	24	2	3	✓	
INNOV200.020.065Z3C	20	20	18,8	115	65	30	0,2	3	✓	
INNOV200.200.060Z3C	20	20	18,8	110	60	30	2	3	✓	0,430
INNOV200.400.060Z3C	20	20	18,8	110	60	30	4	3	✓	
INNOV200.020.100Z3C	20	20	18,8	150	100	30	0,2	3	✓	
INNOV200.200.100Z3C	20	20	18,8	150	100	30	2	3	✓	
INNOV200.400.100Z3C	20	20	18,8	150	100	30	4	3	✓	

Werkzeuge in Ausführung DIN 6535 B, nicht aufgeführte Radien und Werkzeuglängen auf Anfrage.
Shaft version in DIN6535 B, different corner radii and tool lengths on request!

AUFNAHME NACH DIN 6535 HA
ADAPTION ACC. TO DIN 6535 HA

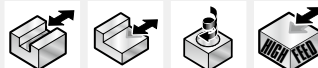

Spezielle HPC Geometrie für die Aluminiumbearbeitung zum Schruppen und Schlichten. Ungleich geteilt mit IK, freigeschliffene Werkzeuggeometrie.
Special HPC geometry for roughing and finishing of aluminum. Irregular pitch with internal coolant, reduced shaft diameter.

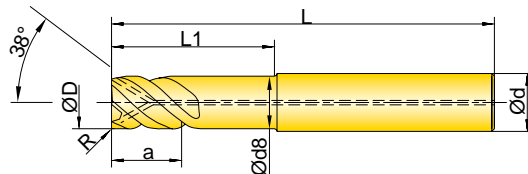

Qualität Grade	P	M	K	N _(K)	S _(M)	H _(PK)	▼	▼	▼	D	e8	λ = 33°	
IN05S				+			▼	▼	R	± 0.05			
							▼	▼	d	h6			

+ Gut geeignet / Preferred choice ○ Bedingt geeignet / Second choice ▼ Schruppen / Roughing ▼▼ Vorschlichten / Pre-finishing ▼▼▼ Schlichten / Finishing

Artikel-Nr. Designation	D	d	d8	L	L1	a	R	Z	IK	kg
INNOV080.020.041Z4C	8	8	7,5	79	41	12	0,2	4	✓	
INNOV080.200.040Z4C	8	8	7,5	79	40	12	2	4	✓	
INNOV100.020.041Z4C	10	10	9,4	83	41	15	0,2	4	✓	
INNOV100.200.041Z4C	10	10	9,4	83	41	15	2	4	✓	
INNOV120.020.041Z4C	12	12	11,3	88	41	18	0,2	4	✓	
INNOV120.200.041Z4C	12	12	11,3	88	41	18	2	4	✓	
INNOV120.400.041Z4C	12	12	11,3	88	41	18	4	4	✓	
INNOV160.050.040Z4C	16	16	15,2	109	60	40	0,5	4	✓	
INNOV160.200.060Z4C	16	16	15,2	109	60	40	2	4	✓	
INNOV160.400.060Z4C	16	16	15,2	109	60	40	4	4	✓	0,270
INNOV160.200.065Z4C	16	16	15,2	114	65	24	2	4	✓	
INNOV160.200.080Z4C	16	16	15,2	128	80	24	2	4	✓	
INNOV200.020.065Z4C	20	20	19,0	115	65	30	0,2	4	✓	
INNOV200.200.060Z4C	20	20	19,0	110	60	30	2	4	✓	
INNOV200.400.060Z4C	20	20	19,0	110	60	30	4	4	✓	
INNOV200.020.100Z4C	20	20	19,0	150	100	30	0,2	4	✓	
INNOV200.200.100Z4C	20	20	19,0	150	100	30	2	4	✓	
INNOV200.400.100Z4C	20	20	19,0	150	100	30	4	4	✓	

Werkzeuge in Ausführung DIN 6535 B, nicht aufgeführte Radien und Werkzeuglängen auf Anfrage.
Shaft version in DIN6535 B, different corner radii and tool lengths on request!

AUFNAHME NACH DIN 6535 HA / 6535 HB
ADAPTION ACC. TO DIN 6535 HA / 6535 HB



Speziell entwickelte HPC-Geometrie für die Schrupp- und Schlichtbearbeitung von Edelstahl und Titan. Ungleiche Teilung und ungleicher Spiralwinkel.
Special developed HPC geometry for rough and finish milling of stainless steel and titanium. Irregular pitch and unequal helix angle.

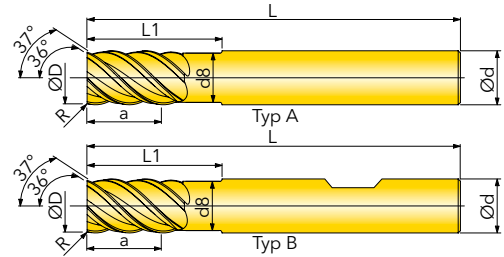

Qualität Grade	P	M	K	N_(K)	S_(M)	H_(PK)		D	h10			
IN2005	○	+	○		+			R	± 0.02			
	+		○					d	h6			

+ Gut geeignet / Preferred choice ○ Bedingt geeignet / Second choice ▼ Schruppen / Roughing ▼▼ Vorschlichten / Pre-finishing ▼▼▼ Schlichten / Finishing

Artikel-Nr. Designation	D	d	d8	L	L1	a	R	Typ	Z	kg
INNOT050.020.020Z4C	5	6	4,9	57	20	13	0,2	A	4	-
INNOT050.050.020Z4C	5	6	4,9	57	20	13	0,5	A	4	-
INNOT060.020.025Z4C	6	6	5,9	57	25	14	0,2	A	4	-
INNOT060.050.025Z4C	6	6	5,9	57	25	14	0,5	A	4	-
INNOT060.100.025Z4C	6	6	5,9	57	25	14	1	A	4	-
INNOT060.200.025Z4C	6	6	5,9	57	25	14	2	A	4	0,026
INNOT080.030.032Z4W	8	8	7,8	68	32	18	0,3	B	4	0,200
INNOT080.080.032Z4C	8	8	7,8	68	32	18	0,8	A	4	0,080
INNOT080.100.032Z4C	8	8	7,8	68	32	18	1	A	4	0,080
INNOT080.200.032Z4C	8	8	7,8	68	32	18	2	A	4	-
INNOT080.300.032Z4C	8	8	7,8	68	32	18	3	A	4	0,040
INNOT100.020.032Z4C	10	10	9,8	72	32	22	0,2	A	4	0,300
INNOT100.080.032Z4C	10	10	9,8	72	32	22	0,8	A	4	-
INNOT100.100.032Z4C	10	10	9,8	72	32	22	1	A	4	-
INNOT100.200.032Z4C	10	10	9,8	72	32	22	2	A	4	-
INNOT100.300.032Z4C	10	10	9,8	72	32	22	3	A	4	-
INNOT100.400.034Z4C	10	10	9,8	72	34	22	4	A	4	-
INNOT120.020.038Z4C	12	12	11,7	83	38	26	0,2	A	4	0,300
INNOT120.080.038Z4C	12	12	11,7	83	38	26	0,8	A	4	-
INNOT120.100.038Z4C	12	12	11,7	83	38	26	1	A	4	-
INNOT120.200.038Z4C	12	12	11,7	83	38	26	2	A	4	-
INNOT120.250.038Z4C	12	12	11,7	83	38	26	2,5	A	4	-
INNOT120.300.038Z4C	12	12	11,7	83	38	26	3	A	4	-
INNOT120.400.038Z4C	12	12	11,7	83	38	26	4	A	4	0,200
INNOT120.400.038Z4W	12	12	11,7	83	38	26	4	B	4	-
INNOT140.020.038Z4C	14	14	13,7	83	38	30	0,2	A	4	-
INNOT140.080.038Z4C	14	14	13,7	83	38	30	0,8	A	4	-
INNOT140.300.038Z4C	14	14	13,7	83	38	30	3	A	4	-
INNOT160.020.050Z4W	16	16	15,7	100	50	34	0,2	B	4	0,300
INNOT160.100.050Z4W	16	16	15,7	100	50	34	1	B	4	0,200
INNOT160.200.050Z4C	16	16	15,7	100	50	34	2	A	4	0,300
INNOT160.250.050Z4C	16	16	15,7	100	50	34	2,5	A	4	-
INNOT160.300.050Z4C	16	16	15,7	100	50	34	3	A	4	-
INNOT160.400.050Z4C	16	16	15,7	100	50	34	4	A	4	-
INNOT160.400.050Z4W	16	16	15,7	100	50	34	4	B	4	-
INNOT160.500.050Z4C	16	16	15,7	100	50	34	5	A	4	-

Artikel-Nr. Designation	D	d	d8	L	L1	a	R	Typ	Z	
INNOT200.020.062Z4W	20	20	19,7	112	62	42	0,2	B	4	-
INNOT200.100.062Z4W	20	20	19,7	112	62	42	1	B	4	-
INNOT200.200.062Z4C	20	20	19,7	112	62	42	2	A	4	0,300
INNOT200.200.062Z4W	20	20	19,7	112	62	42	2	B	4	1,500
INNOT200.250.062Z4C	20	20	19,7	112	62	42	2,5	A	4	-
INNOT200.300.062Z4C	20	20	19,7	112	62	42	3	A	4	-
INNOT200.400.062Z4C	20	20	19,7	112	62	42	4	A	4	-
INNOT200.400.062Z4W	20	20	19,7	112	62	42	4	B	4	-
INNOT200.500.062Z4C	20	20	19,7	112	62	42	5	A	4	-
INNOT250.020.069Z4C	25	25	24,7	125	69	50	0,2	A	4	-
INNOT250.100.069Z4C	25	25	24,7	125	69	50	1	A	4	-
INNOT250.200.069Z4C	25	25	24,7	125	69	50	2	A	4	-
INNOT250.300.069Z4C	25	25	24,7	125	69	50	3	A	4	-
INNOT250.400.069Z4C	25	25	24,7	125	69	50	4	A	4	0,775
INNOT250.400.069Z4W	25	25	24,7	125	69	50	4	B	4	-
INNOT250.500.069Z4C	25	25	24,7	125	69	50	5	A	4	-

Entsprechende Werkzeuge in DIN 6535 HA/HB und nicht aufgeführte Radien und Werkzeuglängen auf Anfrage!
 Shaft version in DIN6535HA/HB, different corner radii and tool lengths on request!

AUFNAHME NACH DIN 6535 HA / 6535 HB
ADAPTION ACC. TO DIN 6535 HA / 6535 HB

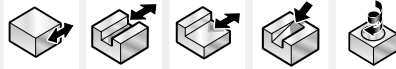

Speziell entwickelte HPC-Geometrie für die Schrupp- und Schlichtbearbeitung von Edelstahl und Titan. Ungleiche Teilung und ungleicher Spiralwinkel.
Special developed HPC geometry for rough and finish milling of stainless steel and titanium. Irregular pitch and unequal helix angle.

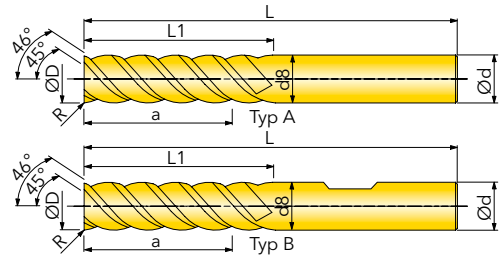

Qualität Grade	P	M	K	N _(K)	S _(M)	H _(PK)		D	h10					
IN2005	+	+	+	+	+	+	▼▼▼	R	± 0.02	43°/43°	54 HRC			
	+	+	+	+	+	+	▼▼▼	d	h6					

Gut geeignet / Preferred choice
 Bedingt geeignet / Second choice
 ▼ Schruppen / Roughing
 ▼▼ Vorschlichten / Pre-finishing
 ▼▼▼ Schlichten / Finishing

Artikel-Nr. Designation	D	d	d8	L	L1	a	R	Typ	Z	kg
INNOT060.010.019Z5C	6	6	5,6	55	19	13	0,1	A	5	-
INNOT060.100.019Z5C	6	6	5,6	55	19	13	1	A	5	-
INNOT080.010.025Z5C	8	8	7,5	61	25	17	0,1	A	5	-
INNOT080.100.025Z5C	8	8	7,5	61	25	17	1	A	5	-
INNOT100.010.033Z5C	10	10	9,5	72	33	22	0,1	A	5	-
INNOT100.100.033Z5C	10	10	9,5	72	33	22	1	A	5	-
INNOT100.200.033Z5C	10	10	9,5	72	33	22	2	A	5	-
INNOT120.020.038Z5C	12	12	11,5	83	38	26	0,2	A	5	-
INNOT120.100.038Z5C	12	12	11,5	83	38	26	1	A	5	-
INNOT120.200.038Z5C	12	12	11,5	83	38	26	2	A	5	-
INNOT120.250.038Z5C	12	12	11,5	83	38	26	2,5	A	5	-
INNOT120.400.038Z5C	12	12	11,5	83	38	26	4	A	5	-
INNOT160.020.050Z5C	16	16	15,5	98	50	34	0,2	A	5	-
INNOT160.020.050Z5W	16	16	15,5	98	50	34	0,2	B	5	-
INNOT160.100.050Z5W	16	16	15,5	98	50	34	1	B	5	-
INNOT160.200.050Z5W	16	16	15,5	98	50	34	2	B	5	-
INNOT160.250.050Z5C	16	16	15,5	98	50	34	2,5	A	5	-
INNOT160.400.050Z5W	16	16	15,5	98	50	34	4	B	5	-
INNOT200.020.062Z5C	20	20	19,5	112	62	42	0,2	A	5	0,450
INNOT200.020.062Z5W	20	20	19,5	112	62	42	0,2	B	5	-
INNOT200.100.062Z5W	20	20	19,5	112	62	42	1	B	5	0,300
INNOT200.200.062Z5W	20	20	19,5	112	62	42	2	B	5	-
INNOT200.250.062Z5C	20	20	19,5	112	62	42	2,5	A	5	-
INNOT200.400.062Z5W	20	20	19,5	112	62	42	4	B	5	0,450

Entsprechende Werkzeuge in DIN 6535 HA/HB und nicht aufgeführte Radien und Werkzeuglängen auf Anfrage!
Shaft version in DIN6535HA/HB, different corner radii and tool lengths on request!

AUFNAHME NACH DIN 6535 HB
 ADAPTION ACC. TO DIN 6535 HB



Speziell entwickelte HPC-Geometrie für die Schrupp- und Schlichtbearbeitung von Edelstahl und Titan. Ungleiche Teilung und ungleicher Spiralwinkel.
 Special developed HPC geometry for rough and finish milling of stainless steel and titanium. Irregular pitch and unequal helix angle.

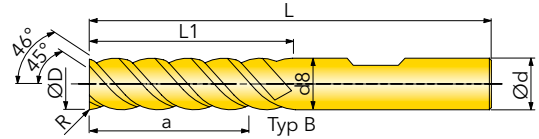

Qualität Grade	P	M	K	N _(K)	S _(M)	H _(PK)	▼	▼▼	▼▼▼	λ	≤54 HRG	
IN2005	○	+	○		+		▼	▼▼	▼▼▼			

+ Gut geeignet / Preferred choice ○ Bedingt geeignet / Second choice ▼ Schruppen / Roughing ▼▼ Vorschlichten / Pre-finishing ▼▼▼ Schlichten / Finishing

Artikel-Nr. Designation	D	d	L	L1	a	R	Z	kg
INNOT120.050.055Z5W	12	12	100	55	46	0,5	5	?
INNOT120.250.055Z5W	12	12	100	55	46	2,5	5	?
INNOT120.400.055Z5W	12	12	100	55	46	4	5	?
INNOT160.050.060Z5W	16	16	109	60	55	0,5	5	?
INNOT160.250.060Z5W	16	16	109	60	55	2,5	5	?
INNOT160.400.060Z5W	16	16	109	60	55	4	5	?
INNOT200.050.076Z5W	20	20	126	76	65	0,5	5	?
INNOT200.250.076Z5W	20	20	126	76	65	2,5	5	?
INNOT200.400.076Z5W	20	20	126	76	65	4	5	?
INNOT200.600.076Z5W	20	20	126	76	65	6	5	?
INNOT250.600.085Z5W	25	25	150	85	80	6	5	?

Entsprechende Werkzeuge in DIN 6535 HA/HB und nicht aufgeführte Radien und Werkzeuglängen auf Anfrage!
 Shaft version in DIN6535HA/HB, different corner radii and tool lengths on request!

AUFNAHME NACH DIN 6535 HA
ADAPTION ACC. TO DIN 6535 HA



Hohes Zerspanvolumen bei weichen und zähen Werkstoffen wie Titan- und Nickellegierungen. VHM-Fräser mit innerer Kühlmittelzufuhr.
High stock removal rate for machining soft and tough materials like titanium and nickel based alloys. Solid carbide mill with internal coolant supply.

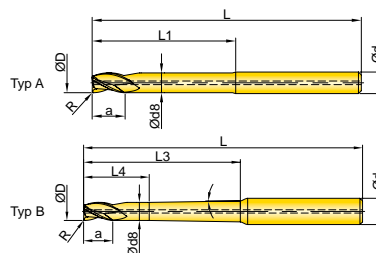

Qualität Grade	P	M	K	N_(K)	S_(M)	H_(PK)	▼	D	0/-0.02			
IN2005	+	○	○		○	+		d	h6			

+ Gut geeignet / Preferred choice
 ○ Bedingt geeignet / Second choice
 ▼ Schruppen / Roughing
 ▼▼ Vorschlichten / Pre-finishing
 ▼▼▼ Schlichten / Finishing

Artikel-Nr. Designation	D	d	d8	L	L1	L3	L4	α	a	R	Typ	Z		
INCO0040.028.010Z3	4	6	3,6	60	10	-	-	-	4	0,28	A	3	✓	0,065
INCO0040.028.020Z3	4	6	3,6	60	20	-	-	-	4	0,28	A	3	✓	0,065
INCO0040.028.040Z3K17	4	6	3,6	80	-	40	12	1,7	4	0,28	B	3	✓	0,065
INCO0040.028.012Z3K14	4	6	3,6	100	-	64	12	1,4	4	0,28	B	3	✓	0,065
INCO0050.035.025Z3	5	6	4,5	60	25	-	-	-	6	0,35	A	3	✓	0,065
INCO0050.035.040Z3	5	6	4,5	75	40	-	-	-	6	0,35	A	3	✓	0,065
INCO0060.042.025Z3	6	6	5,5	60	25	-	-	-	6	0,42	A	3	✓	0,065
INCO0060.042.040Z3	6	6	5,5	75	40	-	-	-	6	0,42	A	3	✓	0,065
INCO0060.042.060Z3	6	6	5,5	100	60	-	-	-	6	0,42	A	3	✓	0,065
INCO0060.042.020Z3K24	6	8	5,6	85	-	40	20	2,4	6	0,42	B	3	✓	0,065
INCO0060.042.020Z3K16	6	8	5,5	100	-	65	20	1,6	6	0,42	B	3	✓	0,065
INCO0060.042.015Z3K24	6	10	5,8	120	-	65	15	1,5	6	0,42	B	3	✓	0,065
INCO0080.056.030Z3	8	8	7,5	65	30	-	-	-	8	0,56	A	3	✓	0,065
INCO0080.056.060Z3	8	8	7,5	100	60	-	-	-	8	0,56	A	3	✓	0,065
INCO0080.056.020Z3K20	8	10	7,6	100	-	45	20	2,0	8	0,56	B	3	✓	0,065
INCO0080.056.020Z3K16	8	10	7,6	120	-	65	20	1,6	8	0,56	B	3	✓	0,065
INCO0100.070.040Z3	10	10	9,6	75	40	-	-	-	8	0,7	A	3	✓	0,065
INCO0100.070.040Z3L	10	10	9,6	100	40	-	-	-	8	0,7	A	3	✓	0,065
INCO0100.110.040Z3	10	10	9,6	75	40	-	-	-	8	1,1	A	3	✓	0,065
INCO0120.080.050Z3	12	12	11,6	125	50	-	-	-	8	0,8	A	3	✓	0,065
INCO0120.110.040Z3	12	12	11,6	80	40	-	-	-	8	1,1	A	3	✓	0,065
INCO0140.170.040Z3	14	14	13,5	89	40	-	-	-	10	1,7	A	3	✓	0,065
INCO0160.190.045Z3	16	16	15,4	100	45	-	-	-	12	1,9	A	3	✓	0,065

R (Programmier-Radius) / R (Programming radius)

FÜR WECHSELKOPFSYSTEM
 FOR EXCHANGEABLE HEAD SYSTEM

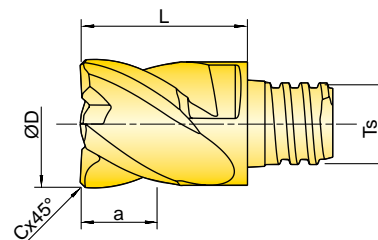
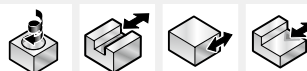

Qualität / Grade

IN1005

P	M	K	N _(K)	S _(M)	H _(PK)
<input type="radio"/>	<input checked="" type="radio"/>			<input checked="" type="radio"/>	



+ gut geeignet / Preferred choice bedingt geeignet / Second choice

Artikel-Nr. Designation	D	L	a	C	Ts	Z	kg	^①
47C08005TQRQ031	8	10	5	0,3	T5	5	0,006	WS-0043
47C10007T6RQ041	10	13	7	0,4	T6	5	0,012	WS-0029
47C12009T8RQ051	12	16,5	9	0,5	T8	5	0,023	WS-0030
47C16012TRRQ061	16	20,5	12	0,6	T10	5	0,049	WS-0044
47C20015TSRQ061	20	25,5	15	0,6	T12	5	0,090	WS-0059
47C25022TURQ061	25	37	22	0,6	T15	5	0,085	WS-0061

Schrupp- / Schlichtfräser ungleich geteilt / unequally spaced

① = Spannschlüssel / Wrench

FÜR WECHSELKOPFSYSTEM
 FOR EXCHANGEABLE HEAD SYSTEM

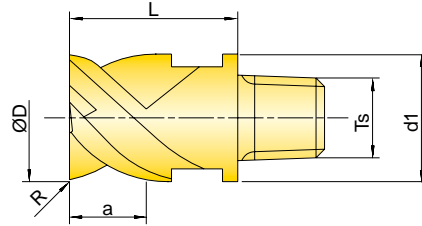
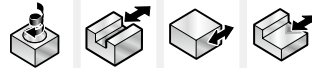

Qualität / Grade

P M K N_(K) S_(M) H_(PK)
 + +

D e8



+ gut geeignet / Preferred choice ○ bedingt geeignet / Second choice

Artikel-Nr. Designation	D	d1	L	a	R	Ts	Z	kg	①
47D08005TQRP0200	8	7,7	10	5	0,2	T5	4	0,005	WS-0043
47D08005TQRP0800	8	7,7	10	5	0,8	T5	4	0,006	WS-0043
47D08005TQRP1000	8	7,7	10	5	1	T5	4	0,006	WS-0043
47D08005TQRP2000	8	7,7	10	5	2	T5	4	0,006	WS-0043
47D08005TQRP3000	8	7,7	10	5	3	T5	4	0,006	WS-0043
47D10007T6RP0200	10	9,6	13	7	0,2	T6	4	0,003	WS-0029
47D10007T6RP0800	10	9,6	13	7	0,8	T6	4		WS-0029
47D10007T6RP1000	10	9,6	13	7	1	T6	4		WS-0029
47D10007T6RP2000	10	9,6	13	7	2	T6	4	0,003	WS-0029
47D10007T6RP3000	10	9,6	13	7	3	T6	4	0,003	WS-0029
47D10007T6RP4000	10	9,6	13	7	4	T6	4		WS-0029
47D12009T8RP0200	12	11,7	16,5	9	0,2	T8	4	0,005	WS-0030
47D12009T8RP0800	12	11,7	16,5	9	0,8	T8	4		WS-0030
47D12009T8RP1000	12	11,7	16,5	9	1	T8	4	0,005	WS-0030
47D12009T8RP2000	12	11,7	16,5	9	2	T8	4		WS-0030
47D12009T8RP3000	12	11,7	16,5	9	3	T8	4		WS-0030
47D12009T8RP4000	12	11,7	16,5	9	4	T8	4		WS-0030
47D16012TRRP0200	16	15,3	20,5	12	0,2	T10	4	0,012	WS-0044
47D16012TRRP1000	16	15,3	20,5	12	1	T10	4	0,012	WS-0044
47D16012TRRP2000	16	15,3	20,5	12	2	T10	4	0,012	WS-0044
47D16012TRRP3000	16	15,3	20,5	12	3	T10	4	0,049	WS-0044
47D16012TRRP4000	16	15,3	20,5	12	4	T10	4	0,500	WS-0044
47D16012TRRP5000	16	15,3	20,5	12	5	T10	4	0,012	WS-0044
47D20015TSRP0200	20	18,3	25,5	15	0,2	T12	4	0,300	WS-0059
47D20015TSRP1000	20	18,3	25,5	15	1	T12	4	0,021	WS-0059
47D20015TSRP2000	20	18,3	25,5	15	2	T12	4		WS-0059
47D20015TSRP3000	20	18,3	25,5	15	3	T12	4		WS-0059
47D20015TSRP4000	20	18,3	25,5	15	4	T12	4		WS-0059
47D20015TSRP5000	20	18,3	25,5	15	5	T12	4		WS-0059
47D25022TURP0200	25	23,9	37	22	0,2	T15	4		WS-0061
47D25022TURP1000	25	23,9	37	22	1	T15	4		WS-0061
47D25022TURP2000	25	23,9	37	22	2	T15	4		WS-0061
47D25022TURP3000	25	23,9	37	22	3	T15	4		WS-0061
47D25022TURP4000	25	23,9	37	22	4	T15	4		WS-0061
47D25022TURP5000	25	23,9	37	22	5	T15	4		WS-0061

Nicht aufgeführte Radien und Werkzeuglängen auf Anfrage. / Additional radius and tool lengths on request.

① = Spannschlüssel / Wrench

FÜR WECHSELKOPFSYSTEM
 FOR EXCHANGEABLE HEAD SYSTEM

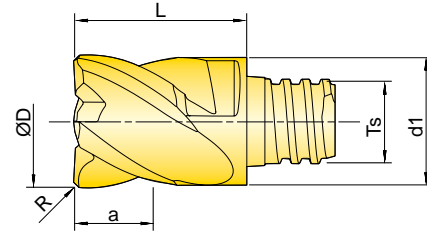
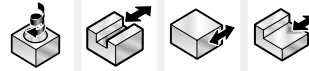

Qualität / Grade
 IN2005

P M K N_(K) S_(M) H_(PK)

D e8



+ gut geeignet / Preferred choice bedingt geeignet / Second choice

Artikel-Nr. Designation	D	d1	L	a	R	Ts	Z	kg	
47D08005TQRP0201	8	7,7	10	5	0,2	T5	5		WS-0043
47D08005TQRP1001	8	7,7	10	5	1	T5	5		WS-0043
47D10007T6RP0101	10	9,6	13	7	0,1	T6	5	0,003	WS-0029
47D10007T6RP1001	10	9,6	13	7	1	T6	5	0,003	WS-0029
47D10007T6RP2001	10	9,6	13	7	2	T6	5		WS-0029
47D12009T8RP0201	12	11,7	16,5	9	0,2	T8	5		WS-0030
47D12009T8RP1001	12	11,7	16,5	9	1	T8	5	0,005	WS-0030
47D12009T8RP2001	12	11,7	16,5	9	2	T8	5		WS-0030
47D12009T8RP4001	12	11,7	16,5	9	4	T8	5		WS-0030
47D16012TRRP0201	16	15,3	20,5	12	0,2	T10	5	0,012	WS-0044
47D16012TRRP1001	16	15,3	20,5	12	1	T10	5	0,012	WS-0044
47D16012TRRP2001	16	15,3	20,5	12	2	T10	5		WS-0044
47D16012TRRP4001	16	15,3	20,5	12	4	T10	5		WS-0044
47D20015TSRP0201	20	18,3	25,5	15	0,2	T12	5		WS-0059
47D20015TSRP1001	20	18,3	25,5	15	1	T12	5		WS-0059
47D20015TSRP2001	20	18,3	25,5	15	2	T12	5		WS-0059
47D20015TSRP4001	20	18,3	25,5	15	4	T12	5		WS-0059
47D25022TURP0201	25	23,9	37	22	0,2	T15	5	0,020	WS-0061
47D25022TURP1001	25	23,9	37	22	1	T15	5		WS-0061
47D25022TURP2001	25	23,9	37	22	2	T15	5		WS-0061
47D25022TURP4001	25	23,9	37	22	4	T15	5		WS-0061

Nicht aufgeführte Radien und Werkzeuglängen auf Anfrage. / Additional radius and tool lengths on request.

① = Spannschlüssel / Wrench

FÜR WECHSELKOPFSYSTEM
FOR EXCHANGEABLE HEAD SYSTEM

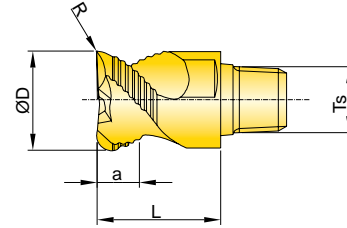

Qualität / Grade
IN05S

P M K N_(K) S_(M) H_(PK)
+

D e8



+ gut geeignet / Preferred choice ○ bedingt geeignet / Second choice

Artikel-Nr. Designation	D	L	a	R	Ts	Z	kg	①
46D08005TQRN02	8	10	5,5	0,2	T5	3	0,006	WS-0043
46D10006T6RN02	10	13	6,5	0,2	T6	3	0,011	WS-0029
46D12008T8RN02	12	16,5	8,5	0,2	T8	3	0,021	WS-0030
46D16010TRRN02	16	20,5	10,7	0,2	T10	3	0,047	WS-0044
46D20012TSRN02	20	25,5	12,7	0,2	T12	3	0,085	WS-0059

auf Anfrage mit Diamantbeschichtung / Diamond coating on request

① = Spannschlüssel / Wrench

FÜR WECHSELKOPFSYSTEM
 FOR EXCHANGEABLE HEAD SYSTEM

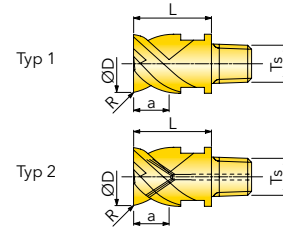
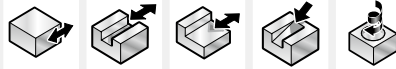

Qualität / Grade

P
M
K
N_(K)
S_(M)
H_(PK)

D e8



IN05S

+

+ gut geeignet / Preferred choice ○ bedingt geeignet / Second choice

Artikel-Nr. Designation	D	L	a	R	Ts	Typ	Z	IK	kg	^①
46D08005TQRD05	8	10	5	0,5	T5	1	3		0,006	WS-0043
46D10007T6RD05	10	13	7	0,5	T6	1	3		0,011	WS-0029
46D10007T6RD10	10	13	7	1	T6	1	3		0,011	WS-0029
46D12008T8RD05	12	16,5	8	0,5	T8	1	3		0,022	WS-0030
46D12008T8RD10	12	16,5	8	1	T8	1	3		0,022	WS-0030
46D12008T8RD30	12	16,5	8	3	T8	1	3		0,022	WS-0030
46J16010TRRD21	16	20,5	10	-	T10	1	3		0,047	WS-0044
46D16010TRRD10	16	20,5	10	1	T10	1	3		0,047	WS-0044
46D16010TRRD20	16	20,5	10	2	T10	1	3		0,047	WS-0044
46D16010TRRD30	16	20,5	10	3	T10	1	3		0,046	WS-0044
46D16010TRRD40	16	20,5	10	4	T10	1	3		0,047	WS-0044
46D20012TSRD05	20	25,5	12	0,5	T12	1	3		0,086	WS-0059
46D20012TSRD10	20	25,5	12	1	T12	1	3		0,085	WS-0059
46D20012TSRD20	20	25,5	12	2	T12	1	3		0,086	WS-0059
46D20012TSRD30	20	25,5	12	3	T12	1	3		0,085	WS-0059
46D20012TSRD40	20	25,5	12	4	T12	1	3		0,084	WS-0059
46D08005TQRD0501	8	10	5	0,5	T5	2	3	✓	0,006	WS-0043
46D10007T6RD0501	10	13	7	0,5	T6	2	3	✓	0,011	WS-0029
46D10007T6RD1001	10	13	7	1	T6	2	3	✓	0,011	WS-0029
46D12008T8RD0501	12	16,5	8	0,5	T8	2	3	✓	0,022	WS-0030
46D12008T8RD1001	12	16,5	8	1	T8	2	3	✓	0,022	WS-0030
46D12008T8RD3001	12	16,5	8	3	T8	2	3	✓	0,022	WS-0030
46J16010TRRD2101	16	20,5	10	-	T10	2	3	✓	0,047	WS-0044
46D16010TRRD1001	16	20,5	10	1	T10	2	3	✓	0,047	WS-0044
46D16010TRRD2001	16	20,5	10	2	T10	2	3	✓	0,047	WS-0044
46D16010TRRD3001	16	20,5	10	3	T10	2	3	✓	0,047	WS-0044
46D16010TRRD4001	16	20,5	10	4	T10	2	3	✓	0,047	WS-0044
46D20012TSRD0501	20	25,5	12	0,5	T12	2	3	✓	0,086	WS-0059
46D20012TSRD1001	20	25,5	12	1	T12	2	3	✓	0,086	WS-0059
46D20012TSRD2001	20	25,5	12	2	T12	2	3	✓	0,086	WS-0059
46D20012TSRD3001	20	25,5	12	3	T12	2	3	✓	0,086	WS-0059
46D20012TSRD4001	20	25,5	12	4	T12	2	3	✓	0,086	WS-0059

auf Anfrage mit Diamantbeschichtung / Diamond coating on request

① = Spanschlüssel / Wrench

FÜR WECHSELKOPFSYSTEM
 FOR EXCHANGEABLE HEAD SYSTEM

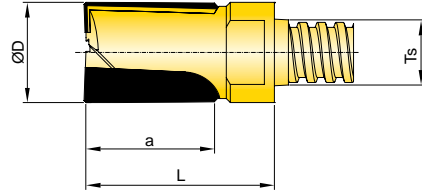
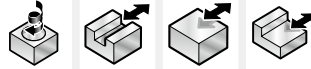

Qualität / Grade
 IN90D

P	M	K	N _(K)	S _(M)	H _(PK)
			+		

D h8



+ gut geeignet / Preferred choice ○ bedingt geeignet / Second choice

Artikel-Nr. Designation	D	L	a	R	Ts	Z	① 
4DD08010QRA022	8	15	10	0,2	T5	2	WS-0043
4DD08010QRA023	8	15	10	0,2	T5	3	WS-0043
4DD08010QRA025	8	15	10	0,2	T5	5	WS-0043
4DD10007T6RA022	10	13	7	0,2	T6	2	WS-0029
4DD10007T6RA023	10	13	7	0,2	T6	3	WS-0029
4DD10013T6RA022	10	19	13	0,2	T6	2	WS-0029
4DD10013T6RF023	10	19	13	0,2	T6	3	WS-0029
4DD10013T6RF025	10	19	13	0,2	T6	5	WS-0029
4DD12009T8RA022	12	16,5	9	0,2	T8	2	WS-0030
4DD12009T8RA023	12	16,5	9	0,2	T8	3	WS-0030
4DD12015T8RA022	12	23	15	0,2	T8	2	WS-0030
4DD12015T8RF027	12	23	15	0,2	T8	7	WS-0030
4DD12009T8RA052	12	16,5	9	0,5	T8	2	WS-0030
4DD12009T8RA053	12	16,5	9	0,5	T8	3	WS-0030
4DD16012TRRA022	16	20,5	12	0,2	T10	2	WS-0044
4DD16012TRRA023	16	20,5	12	0,2	T10	3	WS-0044
4DD16012TRRA025	16	20,5	12	0,2	T10	5	WS-0044
4DD16012TRRA029	16	20,5	12	0,2	T10	9	WS-0044
4DD20015TSRA022	20	25,5	15	0,2	T12	2	WS-0059
4DD20015TSRA023	20	25,5	15	0,2	T12	3	WS-0059
4DJ02015TSRA043	20	25,5	15	0,4	T12	3	WS-0059
4DJ02013TSRA261	20	25,5	15	0,2	T12	4	WS-0059
4DD20023TSRA029	20	34	23	0,2	T12	9	WS-0059

① = Spannschlüssel / Wrench

FÜR WECHSELKOPFSYSTEM
 FOR EXCHANGEABLE HEAD SYSTEM

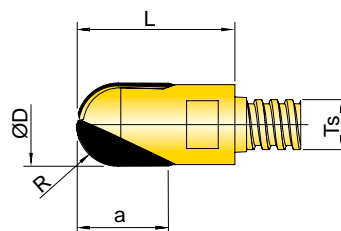

Qualität / Grade

P M K N_(K) S_(M) H_(PK)
 IN90D +

D h8



+ gut geeignet / Preferred choice ○ bedingt geeignet / Second choice

Artikel-Nr.

Designation

D L a Ts Z

①



4DB00805TQRA402	8	10	5	T5	2	WS-0043
4DB10010T6RA502	10	13	10	T6	2	WS-0029
4DB01010T6RA191	10	13	10	T6	2	WS-0029
4DB12009T8RA602	12	16,5	9	T8	2	WS-0030
4DB16012TRRA802	16	20,5	12	T10	2	WS-0044
4DB16012TRRF803	16	20,5	12	T10	3	WS-0044
4DB20014TSRF1003	20	25,5	14	T10	3	WS-0059
4DB02012TSRF261	20	25,5	14	T10	3	WS-0059

① = Spanschlüssel / Wrench

A large grid of small circles, intended for taking notes. The grid consists of 20 columns and 30 rows of circles, each circle being approximately 10x10 units in size. The circles are arranged in a uniform pattern across the page.

AUFNAHME KOMPATIBEL MIT DIN 1835 B
ADAPTION ACC. TO DIN 1835 B

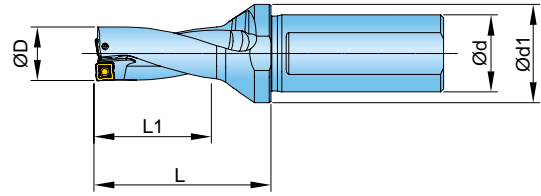

Artikel-Nr. Designation	D	d	d1	L	L1	Z	Zeff		 kg	Passende WSP Related Insert
QR0140028JER00	14,0	20	25	46	28	2	1	✓	0,15	ABC
QR0150030JER00	15,0	20	25	49	30	2	1	✓	0,15	ABC
QR0160032JER00	16,0	20	25	52	32	2	1	✓	0,16	ABC
QR0170034JFR00	17,0	25	32	54	34	2	1	✓	0,27	DEF
QR0175036JFR00	17,5	25	32	57	36	2	1	✓	0,27	DEF
QR0180036JFR00	18,0	25	32	57	36	2	1	✓	0,27	DEF
QR0190038JFR00	19,0	25	32	59	38	2	1	✓	0,28	DEF
QR0195040JFR00	19,5	25	32	63	40	2	1	✓	0,29	GHI
QR0200040JFR00	20,0	25	32	63	40	2	1	✓	0,30	GHI
QR0210042JFR00	21,0	25	32	65	42	2	1	✓	0,30	GHI
QR0220044JFR00	22,0	25	32	67	44	2	1	✓	0,31	GHI
QR0230046JFR00	23,0	25	32	68	46	2	1	✓	0,31	JKL
QR0240048JFR00	24,0	25	32	70	48	2	1	✓	0,33	JKL
QR0250050JFR00	25,0	25	32	72	50	2	1	✓	0,33	JKL
QR0260052JFR00	26,0	25	32	73	52	2	1	✓	0,34	JKL

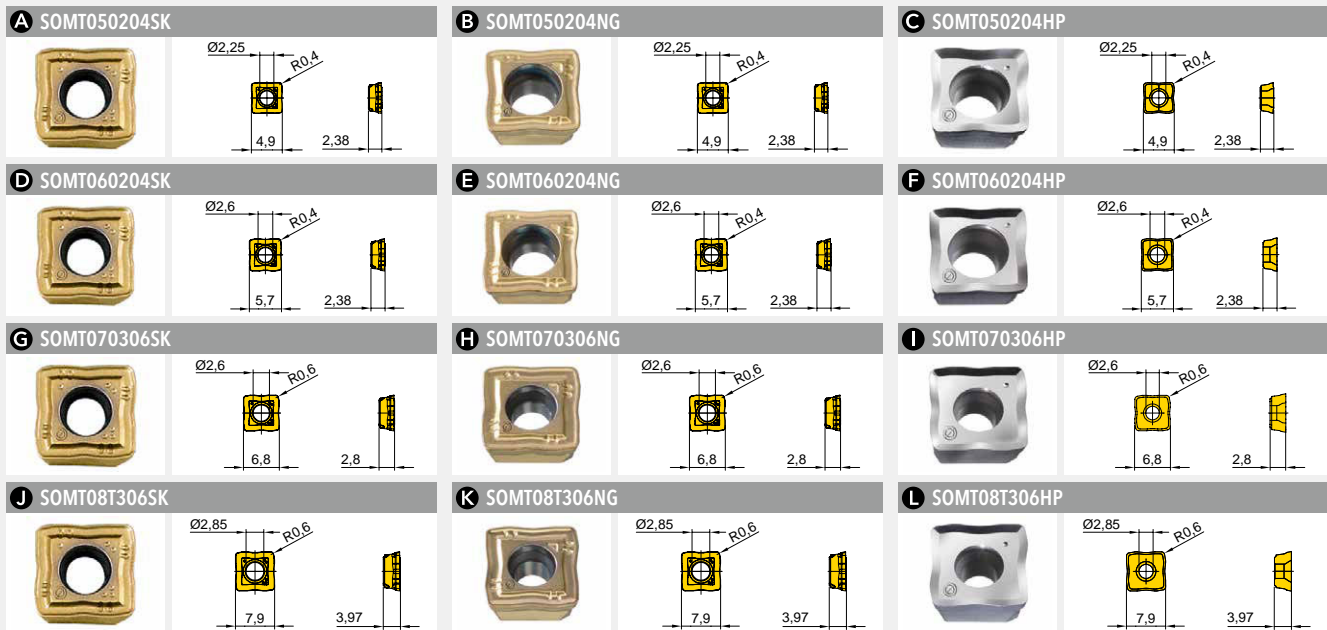

Artikel-Nr. Designation	fz(min/max)	Ausführung Design	Qualität Grade	IN10K	IN2505	IN2510	IN2530	IN6505				
SOMT050204SK ¹⁾	0,04/0,18	positive Geometrie R0,4 / positive geometry R0,4			●		●	●				
SOMT050204NG	0,06/0,15	Gussgeometrie R0,4 / cast iron geometry R0,4				●						
SOMT050204HP	0,06/0,15	NE-Geometrie, poliert R0,4 / non-ferrous geometry, polished R0,4	●									
SOMT060204SK ¹⁾	0,04/0,18	positive Geometrie R0,4 / positive geometry R0,4			●		●	●				
SOMT060204NG	0,06/0,15	Gussgeometrie R0,4 / cast iron geometry R0,4				●						
SOMT060204HP	0,06/0,15	NE-Geometrie, poliert R0,4 / non-ferrous geometry, polished R0,4	●									
SOMT070306SK ¹⁾	0,04/0,20	positive Geometrie R0,6 / positive geometry R0,6			●		●	●				
SOMT070306NG	0,08/0,16	Gussgeometrie R0,6 / cast iron geometry R0,6				●						
SOMT070306HP	0,08/0,16	NE-Geometrie, poliert R0,6 / non-ferrous geometry, polished R0,6	●									
SOMT08T306SK ¹⁾	0,04/0,20	positive Geometrie R0,6 / positive geometry R0,6			●		●	●				
SOMT08T306NG	0,08/0,16	Gussgeometrie R0,6 / cast iron geometry R0,6				●						
SOMT08T306HP	0,08/0,16	NE-Geometrie, poliert R0,6 / non-ferrous geometry, polished R0,6	●									

¹⁾ IN6505 nur als Umfangsschneide verwenden. / Use IN6505 grade only for peripheral inserts

● = P ● = M ● = K ● = N ● = S ○ = H

ZUBEHÖR SPARE PARTS		①	②
Durchmesserbereich / Diameter Range			
14,0 - 16,0	SM20-043-00 (0,7Nm) DS-TP06S (TX-Plus)		
17,0 - 22,0	TS 22052I/HG-P (0,8Nm) DS-TP07S (TX-Plus)		
23,0 - 26,0	SO 25065I (1,1Nm) DS-T07S		

① = Spannschraube / Insert screw ② = Schraubendreher / Screw driver

AUFNAHME KOMPATIBEL MIT DIN 1835 B
ADAPTION ACC. TO DIN 1835 B

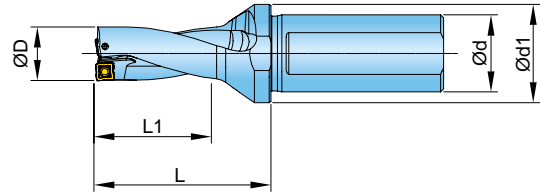

Artikel-Nr. Designation	D	d	d1	L	L1	Z	Zeff			Passende WSP Related Insert
QR0270054JFR00	27,0	25	40	77	54	2	1	✓	0,49	ABC
QR0280056JFR00	28,0	25	40	79	56	2	1	✓	0,52	ABC
QR0290058JGR00	29,0	32	40	81	58	2	1	✓	0,66	ABC
QR0300060JGR00	30,0	32	40	83	60	2	1	✓	0,78	ABC
QR0310062JGR00	31,0	32	40	85	62	2	1	✓	0,81	ABC
QR0320064JGR00	32,0	32	40	87	64	2	1	✓	0,84	DEF
QR0330066JGR00	33,0	32	40	89	66	2	1	✓	0,87	DEF
QR0340068JGR00	34,0	32	40	91	68	2	1	✓	0,89	DEF
QR0350070JGR00	35,0	32	40	93	70	2	1	✓	0,92	DEF
QR0360072JGR00	36,0	32	40	95	72	2	1	✓	0,96	DEF
QR0370074JGR00	37,0	32	50	102	74	2	1	✓	0,97	GHI
QR0380076JGR00	38,0	32	50	104	76	2	1	✓	1,00	GHI
QR0390078JGR00	39,0	32	50	106	78	2	1	✓	1,05	GHI
QR0400080JGR00	40,0	32	50	108	80	2	1	✓	1,10	GHI
QR0410082JHR00	41,0	40	50	110	82	2	1	✓	1,48	GHI
QR0420084JHR00	42,0	40	50	112	84	2	1	✓	1,50	GHI
QR0430086JHR00	43,0	40	50	114	86	2	1	✓	1,55	GHI
QR0440088JHR00	44,0	40	60	123	88	2	1	✓	1,60	JKL
QR0450090JHR00	45,0	40	60	125	90	2	1	✓	1,66	JKL
QR0460092JHR00	46,0	40	60	127	92	2	1	✓	1,71	JKL
QR0470094JHR00	47,0	40	60	129	94	2	1	✓	1,76	JKL
QR0480096JHR00	48,0	40	60	131	96	2	1	✓	1,84	JKL
QR0490098JHR00	49,0	40	60	133	98	2	1	✓	1,86	JKL
QR0500100JHR00	50,0	40	60	135	100	2	1	✓	1,93	JKL

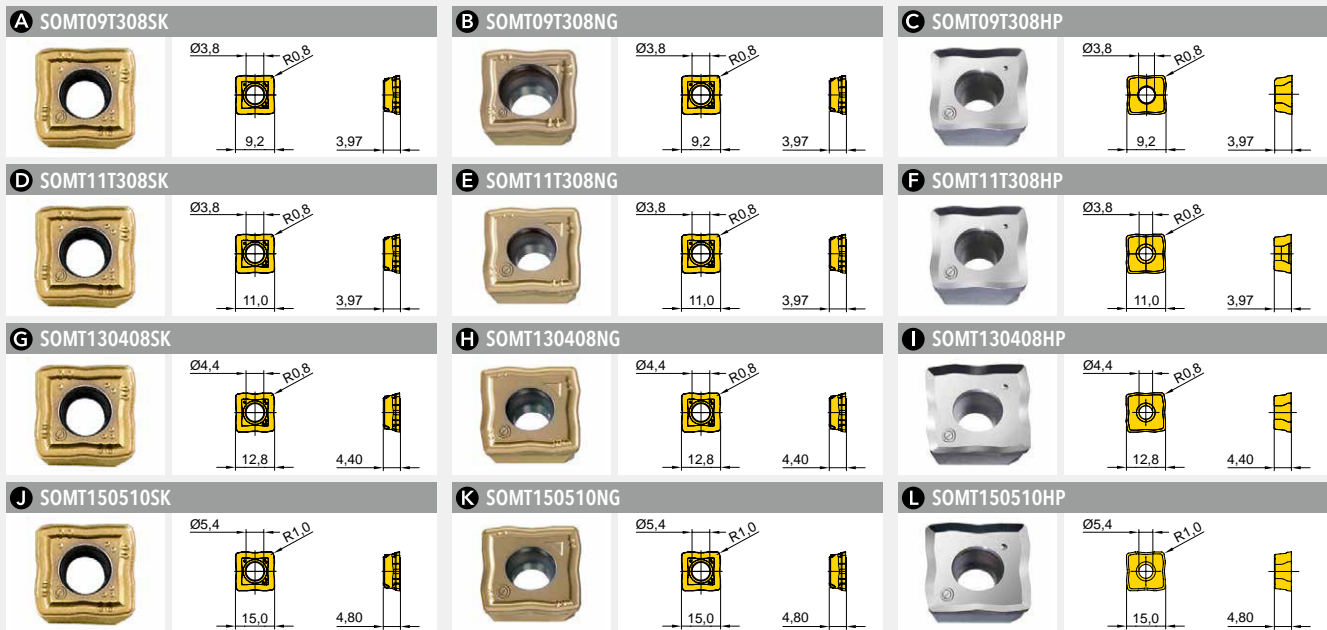

Artikel-Nr. Designation	fz(min/max)	Ausführung Design	Qualität Grade	IN10K	IN2505	IN2510	IN2530	IN6505			
SOMT09T308SK ¹⁾	0,06/0,20	positive Geometrie R0,8 / positive geometry R0,8			●		●	●			
SOMT09T308NG	0,08/0,18	Gussgeometrie R0,8 / cast iron geometry R0,8				●					
SOMT09T308HP	0,08/0,18	NE-Geometrie, poliert R0,8 / non-ferrous geometry, polished R0,8	●								
SOMT11T308SK ¹⁾	0,06/0,22	positive Geometrie R0,8 / positive geometry R0,8			●		●	●			
SOMT11T308NG	0,08/0,18	Gussgeometrie R0,8 / cast iron geometry R0,8				●					
SOMT11T308HP	0,08/0,18	NE-Geometrie, poliert R0,8 / non-ferrous geometry, polished R0,8	●								
SOMT130408SK ¹⁾	0,06/0,22	positive Geometrie R0,8 / positive geometry R0,8			●		●	●			
SOMT130408NG	0,10/0,18	Gussgeometrie R0,8 / cast iron geometry R0,8				●					
SOMT130408HP	0,10/0,18	NE-Geometrie, poliert R0,8 / non-ferrous geometry, polished R0,8	●								
SOMT150510SK ¹⁾	0,06/0,24	positive Geometrie R1,0 / positive geometry R1,0			●		●	●			
SOMT150510NG	0,10/0,18	Gussgeometrie R1,0 / cast iron geometry R1,0				●					
SOMT150510HP	0,10/0,18	NE-Geometrie, poliert R1,0 / non-ferrous geometry, polished R1,0	●								

¹⁾ IN6505 nur als Umfangsschneide verwenden. / Use IN6505 grade only for peripheral inserts

● = P ● = M ● = K ● = N ● = S ○ = H

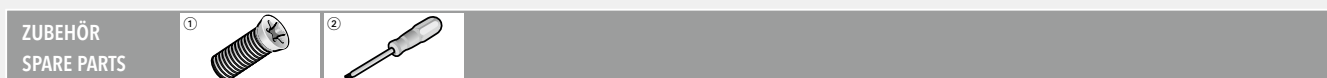

Durchmesserbereich / Diameter Range

27,0 - 36,0	SM35-088-60 (3,0Nm) DS-T10S
37,0 - 43,0	SM40-093-20 (4,5Nm) DS-T15S
44,0 - 50,0	SM50-113-20 (8,0Nm) DS-T20S

① = Spannschraube / Insert screw ② = Schraubendreher / Screw driver

AUFNAHME KOMPATIBEL MIT DIN 1835 B
ADAPTION ACC. TO DIN 1835 B

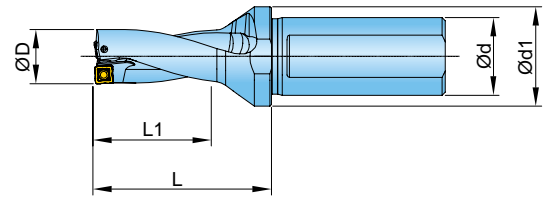

Artikel-Nr. Designation	D	d	d1	L	L1	Z	Zeff			Passende WSP Related Insert
QR0140042JER00	14,0	20	25	60	42	2	1	✓	0,16	ABC
QR0145045JER00	14,5	20	25	64	45	2	1	✓	0,16	ABC
QR0150045JER00	15,0	20	25	64	45	2	1	✓	0,16	ABC
QR0155048JER00	15,5	20	25	68	48	2	1	✓	0,17	ABC
QR0160048JER00	16,0	20	25	68	48	2	1	✓	0,17	ABC
QR0165051JFR00	16,5	25	32	71	51	2	1	✓	0,28	DEF
QR0170051JFR00	17,0	25	32	71	51	2	1	✓	0,28	DEF
QR0175054JFR00	17,5	25	32	75	54	2	1	✓	0,28	DEF
QR0180054JFR00	18,0	25	32	75	54	2	1	✓	0,29	DEF
QR0185057JFR00	18,5	25	32	78	57	2	1	✓	0,29	DEF
QR0190057JFR00	19,0	25	32	78	57	2	1	✓	0,30	DEF
QR0195060JFR00	19,5	25	32	83	60	2	1	✓	0,31	GHI
QR0200060JFR00	20,0	25	32	83	60	2	1	✓	0,32	GHI
QR0205063JFR00	20,5	25	32	86	63	2	1	✓	0,32	GHI
QR0210063JFR00	21,0	25	32	86	63	2	1	✓	0,33	GHI
QR0215066JFR00	21,5	25	32	89	66	2	1	✓	0,33	GHI
QR0220066JFR00	22,0	25	32	89	66	2	1	✓	0,34	GHI
QR0225069JFR00	22,5	25	32	91	69	2	1	✓	0,34	JKL
QR0230069JFR00	23,0	25	32	91	69	2	1	✓	0,35	JKL
QR0235072JFR00	23,5	25	32	94	72	2	1	✓	0,36	JKL
QR0240072JFR00	24,0	25	32	94	72	2	1	✓	0,36	JKL
QR0245075JFR00	24,5	25	32	97	75	2	1	✓	0,37	JKL
QR0250075JFR00	25,0	25	32	97	75	2	1	✓	0,37	JKL
QR0255078JFR00	25,5	25	32	99	78	2	1	✓	0,38	JKL
QR0260078JFR00	26,0	25	32	99	78	2	1	✓	0,39	JKL

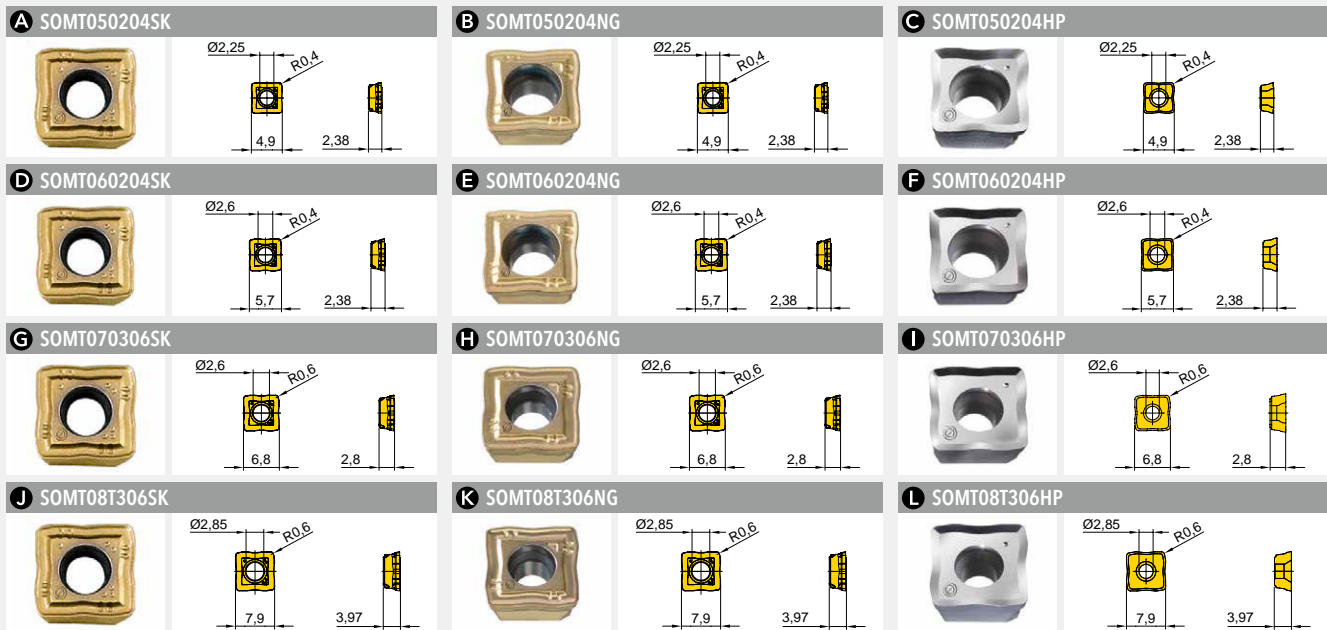

Artikel-Nr. Designation	fz(min/max)	Ausführung Design	Qualität Grade	IN10K	IN2505	IN2510	IN2530	IN6505			
SOMT050204SK ¹⁾	0,04/0,18	positive Geometrie R0,4 / positive geometry R0,4			●		●	●			
SOMT050204NG	0,06/0,15	Gussgeometrie R0,4 / cast iron geometry R0,4				●					
SOMT050204HP	0,06/0,15	NE-Geometrie, poliert R0,4 / non-ferrous geometry, polished R0,4	●								
SOMT060204SK ¹⁾	0,04/0,18	positive Geometrie R0,4 / positive geometry R0,4			●		●	●			
SOMT060204NG	0,06/0,15	Gussgeometrie R0,4 / cast iron geometry R0,4				●					
SOMT060204HP	0,06/0,15	NE-Geometrie, poliert R0,4 / non-ferrous geometry, polished R0,4	●								
SOMT070306SK ¹⁾	0,04/0,20	positive Geometrie R0,6 / positive geometry R0,6			●		●	●			
SOMT070306NG	0,08/0,16	Gussgeometrie R0,6 / cast iron geometry R0,6				●					
SOMT070306HP	0,08/0,16	NE-Geometrie, poliert R0,6 / non-ferrous geometry, polished R0,6	●								
SOMT08T306SK ¹⁾	0,04/0,20	positive Geometrie R0,6 / positive geometry R0,6			●		●	●			
SOMT08T306NG	0,08/0,16	Gussgeometrie R0,6 / cast iron geometry R0,6				●					
SOMT08T306HP	0,08/0,16	NE-Geometrie, poliert R0,6 / non-ferrous geometry, polished R0,6	●								

¹⁾ IN6505 nur als Umfangsschneide verwenden. / Use IN6505 grade only for peripheral inserts

● = P ● = M ● = K ● = N ● = S ○ = H

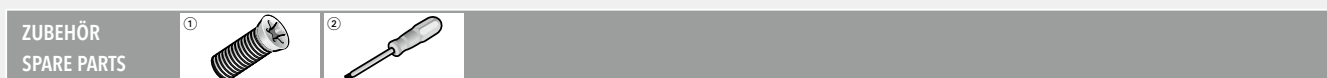

Durchmesserbereich / Diameter Range

14,0 - 16,0	SM20-043-00 (0,7Nm)	DS-TP06S (TX-Plus)
16,5 - 22,0	TS 22052I/HG-P (0,8Nm)	DS-TP07S (TX-Plus)
22,5 - 26,0	SO 25065I (1,1Nm)	DS-T07S

① = Spannschraube / Insert screw ② = Schraubendreher / Screw driver

AUFNAHME KOMPATIBEL MIT DIN 1835 B
ADAPTION ACC. TO DIN 1835 B

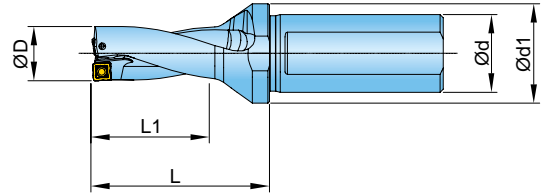

Artikel-Nr. Designation	D	d	d1	L	L1	Z	Zeff			Passende WSP Related Insert
QR0265081JFR00	26,5	25	40	104	81	2	1	✓	0,53	ABC
QR0270081JFR00	27,0	25	40	104	81	2	1	✓	0,53	ABC
QR0275084JFR00	27,5	25	40	107	84	2	1	✓	0,56	ABC
QR0280084JFR00	28,0	25	40	107	84	2	1	✓	0,56	ABC
QR0285087JGR00	28,5	32	40	110	87	2	1	✓	0,75	ABC
QR0290087JGR00	29,0	32	40	110	87	2	1	✓	0,75	ABC
QR0295090JGR00	29,5	32	40	113	90	2	1	✓	0,85	ABC
QR0300090JGR00	30,0	32	40	113	90	2	1	✓	0,85	ABC
QR0310093JGR00	31,0	32	40	116	93	2	1	✓	0,90	ABC
QR0320096JGR00	32,0	32	40	119	96	2	1	✓	0,93	DEF
QR0330099JGR00	33,0	32	40	122	99	2	1	✓	0,97	DEF
QR0340102JGR00	34,0	32	40	125	102	2	1	✓	1,01	DEF
QR0345105JGR00	34,5	32	40	128	105	2	1	✓	1,04	DEF
QR0350105JGR00	35,0	32	40	128	105	2	1	✓	1,04	DEF
QR0360108JGR00	36,0	32	40	131	108	2	1	✓	1,07	DEF
QR0370111JGR00	37,0	32	50	139	111	2	1	✓	1,12	GHI
QR0375114JGR00	37,5	32	50	142	114	2	1	✓	1,17	GHI
QR0380114JGR00	38,0	32	50	142	114	2	1	✓	1,17	GHI
QR0390117JGR00	39,0	32	50	145	117	2	1	✓	1,23	GHI
QR0400120JGR00	40,0	32	50	148	120	2	1	✓	1,31	GHI
QR0405123JGR00	40,5	40	50	151	123	2	1	✓	1,48	GHI
QR0410123JHR00	41,0	40	50	151	123	2	1	✓	1,48	GHI
QR0420126JHR00	42,0	40	50	154	126	2	1	✓	1,62	GHI
QR0430129JHR00	43,0	40	50	157	129	2	1	✓	1,78	GHI
QR0440132JHR00	44,0	40	60	167	132	2	1	✓	1,83	JKL
QR0450135JHR00	45,0	40	60	170	135	2	1	✓	1,92	JKL
QR0460138JHR00	46,0	40	60	173	138	2	1	✓	1,99	JKL
QR0465141JHR00	46,5	40	60	176	141	2	1	✓	2,05	JKL
QR0470141JHR00	47,0	40	60	176	141	2	1	✓	2,05	JKL
QR0480144JHR00	48,0	40	60	179	144	2	1	✓	2,11	JKL
QR0490147JHR00	49,0	40	60	182	147	2	1	✓	2,16	JKL
QR0500150JHR00	50,0	40	60	185	150	2	1	✓	2,26	JKL
QR0505153JHR00	50,5	40	60	188	153	2	1	✓	2,30	JKL

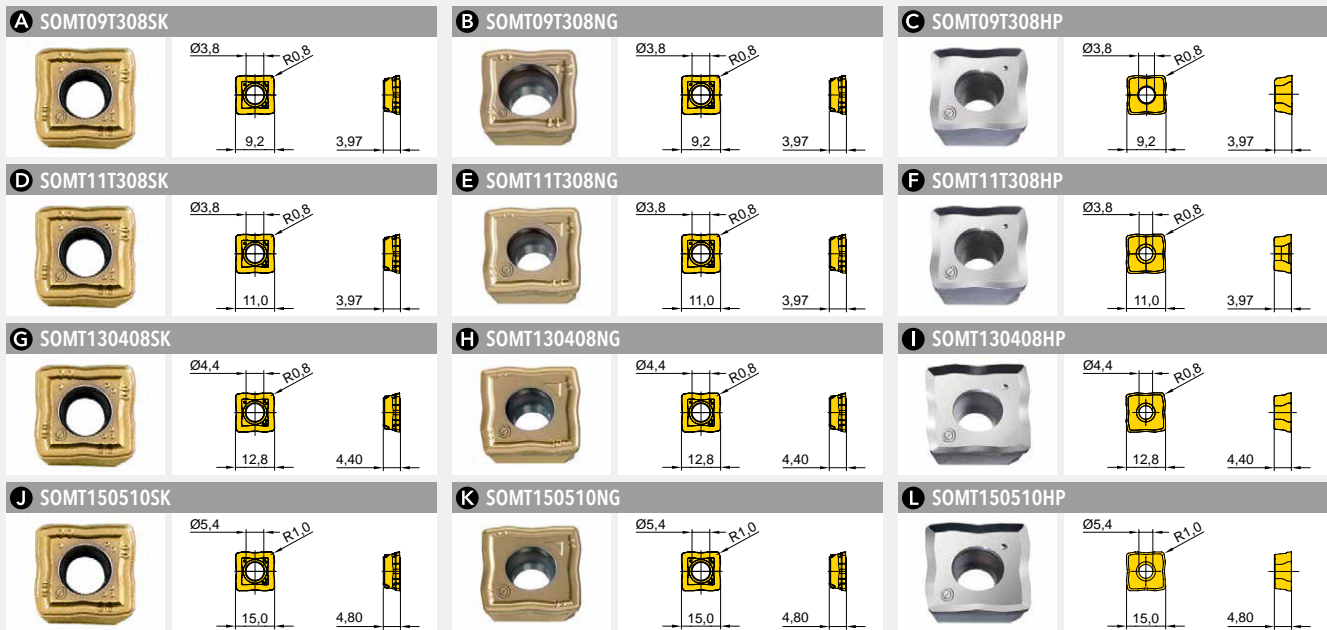

Artikel-Nr. Designation	fz(min/max)	Ausführung Design	Qualität Grade	IN10K	IN2505	IN2510	IN2530	IN6505			
SOMT09T308SK ¹⁾	0,06/0,20	positive Geometrie R0,8 / positive geometry R0,8			●		●	●			
SOMT09T308NG	0,08/0,18	Gussgeometrie R0,8 / cast iron geometry R0,8				●					
SOMT09T308HP	0,08/0,18	NE-Geometrie, poliert R0,8 / non-ferrous geometry, polished R0,8	●								
SOMT11T308SK ¹⁾	0,06/0,22	positive Geometrie R0,8 / positive geometry R0,8			●		●	●			
SOMT11T308NG	0,08/0,18	Gussgeometrie R0,8 / cast iron geometry R0,8				●					
SOMT11T308HP	0,08/0,18	NE-Geometrie, poliert R0,8 / non-ferrous geometry, polished R0,8	●								
SOMT130408SK ¹⁾	0,06/0,22	positive Geometrie R0,8 / positive geometry R0,8			●		●	●			
SOMT130408NG	0,10/0,18	Gussgeometrie R0,8 / cast iron geometry R0,8				●					
SOMT130408HP	0,10/0,18	NE-Geometrie, poliert R0,8 / non-ferrous geometry, polished R0,8	●								
SOMT150510SK ¹⁾	0,06/0,24	positive Geometrie R1,0 / positive geometry R1,0			●		●	●			
SOMT150510NG	0,10/0,18	Gussgeometrie R1,0 / cast iron geometry R1,0				●					
SOMT150510HP	0,10/0,18	NE-Geometrie, poliert R1,0 / non-ferrous geometry, polished R1,0	●								

¹⁾ IN6505 nur als Umfangsschneide verwenden. / Use IN6505 grade only for peripheral inserts

● = P ● = M ● = K ● = N ● = S ○ = H

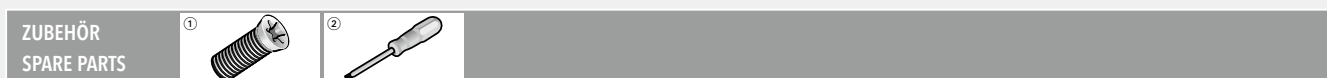

Durchmesserbereich / Diameter Range

26,5 - 36,0	SM35-088-60 (3,0Nm) DS-T10S
37,0 - 43,0	SM40-093-20 (4,5Nm) DS-T15S
44,0 - 50,5	SM50-113-20 (8,0Nm) DS-T20S

① = Spannschraube / Insert screw ② = Schraubendreher / Screw driver

AUFNAHME KOMPATIBEL MIT DIN 1835 B
ADAPTION ACC. TO DIN 1835 B

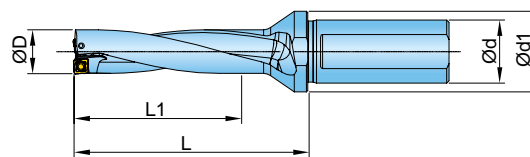

Artikel-Nr. Designation	D	d	d1	L	L1	Z	Zeff	🚰	📊 kg	Passende WSP Related Insert
QR0140056JER00	14,0	20	25	74	56	2	1	✓	0,16	ABC
QR0150060JER00	15,0	20	25	79	60	2	1	✓	0,17	ABC
QR0160064JER00	16,0	20	25	84	64	2	1	✓	0,18	ABC
QR0170068JFR00	17,0	25	32	88	68	2	1	✓	0,29	DEF
QR0175072JFR00	17,5	25	32	93	72	2	1	✓	0,30	DEF
QR0180072JFR00	18,0	25	32	93	72	2	1	✓	0,30	DEF
QR0190076JFR00	19,0	25	32	97	76	2	1	✓	0,32	DEF
QR0195080JFR00	19,5	25	32	103	80	2	1	✓	0,34	GHI
QR0200080JFR00	20,0	25	32	103	80	2	1	✓	0,34	GHI
QR0210084JFR00	21,0	25	32	107	84	2	1	✓	0,35	GHI
QR0220088JFR00	22,0	25	32	111	88	2	1	✓	0,37	GHI
QR0230092JFR00	23,0	25	32	114	92	2	1	✓	0,38	JKL
QR0240096JFR00	24,0	25	32	118	96	2	1	✓	0,41	JKL
QR0250100JFR00	25,0	25	32	122	100	2	1	✓	0,42	JKL
QR0260104JFR00	26,0	25	32	125	104	2	1	✓	0,45	JKL

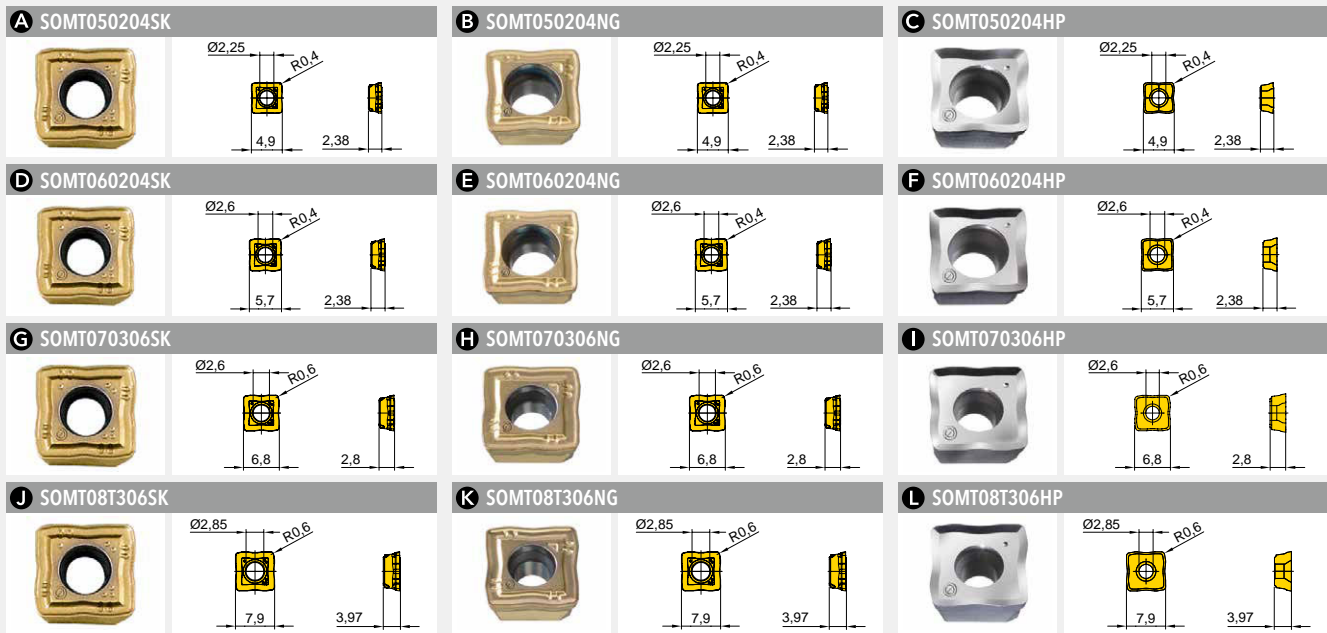

Artikel-Nr. Designation	fz(min/max)	Ausführung Design	Qualität Grade	IN10K	IN2505	IN2510	IN2530	IN6505			
SOMT050204SK ¹⁾	0,04/0,18	positive Geometrie R0,4 / positive geometry R0,4			●		●	●			
SOMT050204NG	0,06/0,15	Gussgeometrie R0,4 / cast iron geometry R0,4				●					
SOMT050204HP	0,06/0,15	NE-Geometrie, poliert R0,4 / non-ferrous geometry, polished R0,4	●								
SOMT060204SK ¹⁾	0,04/0,18	positive Geometrie R0,4 / positive geometry R0,4			●		●	●			
SOMT060204NG	0,06/0,15	Gussgeometrie R0,4 / cast iron geometry R0,4				●					
SOMT060204HP	0,06/0,15	NE-Geometrie, poliert R0,4 / non-ferrous geometry, polished R0,4	●								
SOMT070306SK ¹⁾	0,04/0,20	positive Geometrie R0,6 / positive geometry R0,6			●		●	●			
SOMT070306NG	0,08/0,16	Gussgeometrie R0,6 / cast iron geometry R0,6				●					
SOMT070306HP	0,08/0,16	NE-Geometrie, poliert R0,6 / non-ferrous geometry, polished R0,6	●								
SOMT08T306SK ¹⁾	0,04/0,20	positive Geometrie R0,6 / positive geometry R0,6			●		●	●			
SOMT08T306NG	0,08/0,16	Gussgeometrie R0,6 / cast iron geometry R0,6				●					
SOMT08T306HP	0,08/0,16	NE-Geometrie, poliert R0,6 / non-ferrous geometry, polished R0,6	●								

¹⁾ IN6505 nur als Umfangsschneide verwenden. / Use IN6505 grade only for peripheral inserts

● = P ● = M ● = K ● = N ● = S ○ = H

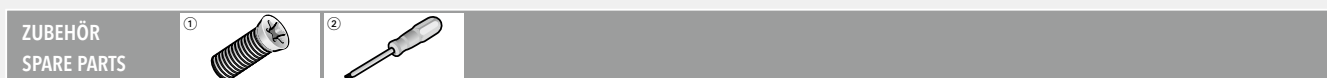

Durchmesserbereich / Diameter Range

14,0 - 16,0	SM20-043-00 (0,7Nm)	DS-TP06S (TX-Plus)
17,0 - 22,0	TS 22052I/HG-P (0,8Nm)	DS-TP07S (TX-Plus)
23,0 - 26,0	SO 25065I (1,1Nm)	DS-T07S

① = Spanschraube / Insert screw ② = Schraubendreher / Screw driver

AUFNAHME KOMPATIBEL MIT DIN 1835 B
ADAPTION ACC. TO DIN 1835 B

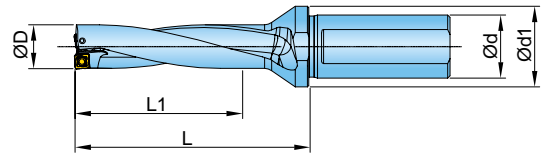

Artikel-Nr. Designation	D	d	d1	L	L1	Z	Zeff	IK	kg	Passende WSP Related Insert
QR0270108JFR00	27,0	25	40	131	108	2	1	✓	0,59	ABC
QR0280112JFR00	28,0	25	40	135	112	2	1	✓	0,62	ABC
QR0290116JGR00	29,0	32	40	139	116	2	1	✓	0,80	ABC
QR0300120JGR00	30,0	32	40	143	120	2	1	✓	0,94	ABC
QR0310124JGR00	31,0	32	40	147	124	2	1	✓	0,97	ABC
QR0320128JGR00	32,0	32	40	151	128	2	1	✓	1,04	DEF
QR0330132JGR00	33,0	32	40	155	132	2	1	✓	1,09	DEF
QR0340136JGR00	34,0	32	40	159	136	2	1	✓	1,13	DEF
QR0350140JGR00	35,0	32	40	163	140	2	1	✓	1,17	DEF
QR0360144JGR00	36,0	32	40	167	144	2	1	✓	1,23	DEF
QR0370148JGR00	37,0	32	50	176	148	2	1	✓	1,29	GHI
QR0380152JGR00	38,0	32	50	180	152	2	1	✓	1,34	GHI
QR0390156JGR00	39,0	32	50	184	156	2	1	✓	1,41	GHI
QR0400160JGR00	40,0	32	50	188	160	2	1	✓	1,50	GHI
QR0410164JHR00	41,0	40	50	192	164	2	1	✓	1,86	GHI
QR0420168JHR00	42,0	40	50	196	168	2	1	✓	1,94	GHI
QR0430172JHR00	43,0	40	50	200	172	2	1	✓	2,02	GHI
QR0440176JHR00	44,0	40	60	211	176	2	1	✓	2,10	JKL
QR0450180JHR00	45,0	40	60	215	180	2	1	✓	2,19	JKL
QR0460184JHR00	46,0	40	60	219	184	2	1	✓	2,30	JKL
QR0470188JHR00	47,0	40	60	223	188	2	1	✓	2,37	JKL
QR0480192JHR00	48,0	40	60	227	192	2	1	✓	2,47	JKL
QR0490196JHR00	49,0	40	60	231	196	2	1	✓	2,59	JKL
QR0500200JHR00	50,0	40	60	235	200	2	1	✓	2,64	JKL

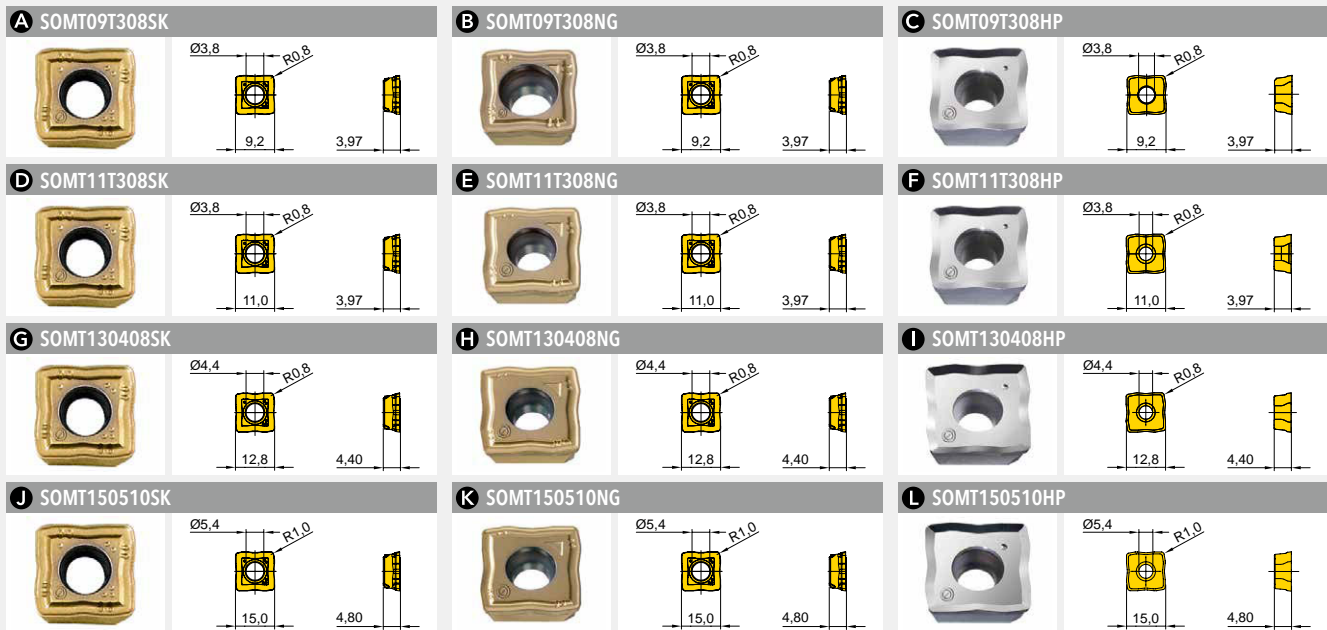

Artikel-Nr. Designation	fz(min/max)	Ausführung Design	Qualität Grade	IN10K	IN2505	IN2510	IN2530	IN6505			
SOMT09T308SK ¹⁾	0,06/0,20	positive Geometrie R0,8 / positive geometry R0,8			●		●	●			
SOMT09T308NG	0,08/0,18	Gussgeometrie R0,8 / cast iron geometry R0,8				●					
SOMT09T308HP	0,08/0,18	NE-Geometrie, poliert R0,8 / non-ferrous geometry, polished R0,8	●								
SOMT11T308SK ¹⁾	0,06/0,22	positive Geometrie R0,8 / positive geometry R0,8			●		●	●			
SOMT11T308NG	0,08/0,18	Gussgeometrie R0,8 / cast iron geometry R0,8				●					
SOMT11T308HP	0,08/0,18	NE-Geometrie, poliert R0,8 / non-ferrous geometry, polished R0,8	●								
SOMT130408SK ¹⁾	0,06/0,22	positive Geometrie R0,8 / positive geometry R0,8			●		●	●			
SOMT130408NG	0,10/0,18	Gussgeometrie R0,8 / cast iron geometry R0,8				●					
SOMT130408HP	0,10/0,18	NE-Geometrie, poliert R0,8 / non-ferrous geometry, polished R0,8	●								
SOMT150510SK ¹⁾	0,06/0,24	positive Geometrie R1,0 / positive geometry R1,0			●		●	●			
SOMT150510NG	0,10/0,18	Gussgeometrie R1,0 / cast iron geometry R1,0				●					
SOMT150510HP	0,10/0,18	NE-Geometrie, poliert R1,0 / non-ferrous geometry, polished R1,0	●								

¹⁾ IN6505 nur als Umfangsschneide verwenden. / Use IN6505 grade only for peripheral inserts

● = P ● = M ● = K ● = N ● = S ○ = H

ZUBEHÖR SPARE PARTS	①	②
Durchmesserbereich / Diameter Range		
27,0 - 36,0	SM35-088-60 (3,0Nm) DS-T10S	
37,0 - 43,0	SM40-093-20 (4,5Nm) DS-T15S	
44,0 - 50,0	SM50-113-20 (8,0Nm) DS-T20S	

① = Spannschraube / Insert screw ② = Schraubendreher / Screw driver

AUFNAHME KOMPATIBEL MIT DIN 1835 B
 ADAPTION ACC. TO DIN 1835 B

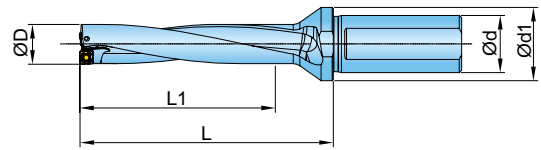

Artikel-Nr. Designation	D	d	d1	L	L1	Z	Zeff		 kg	Passende WSP Related Insert
QR0140070JER00	14,0	20	25	88	70	2	1	✓	0,17	ABC
QR0150075JER00	15,0	20	25	94	75	2	1	✓	0,18	ABC
QR0160080JER00	16,0	20	25	100	80	2	1	✓	0,19	ABC
QR0170085JFR00	17,0	25	32	105	85	2	1	✓	0,31	DEF
QR0180090JFR00	18,0	25	32	111	90	2	1	✓	0,32	DEF
QR0190095JFR00	19,0	25	32	116	95	2	1	✓	0,34	DEF
QR0200100JFR00	20,0	25	32	123	100	2	1	✓	0,36	GHI
QR0210105JFR00	21,0	25	32	128	105	2	1	✓	0,38	GHI
QR0220110JFR00	22,0	25	32	133	110	2	1	✓	0,40	GHI
QR0230115JFR00	23,0	25	32	137	115	2	1	✓	0,42	JKL
QR0240120JFR00	24,0	25	32	142	120	2	1	✓	0,45	JKL
QR0250125JFR00	25,0	25	32	147	125	2	1	✓	0,46	JKL
QR0260130JFR00	26,0	25	32	151	130	2	1	✓	0,50	JKL

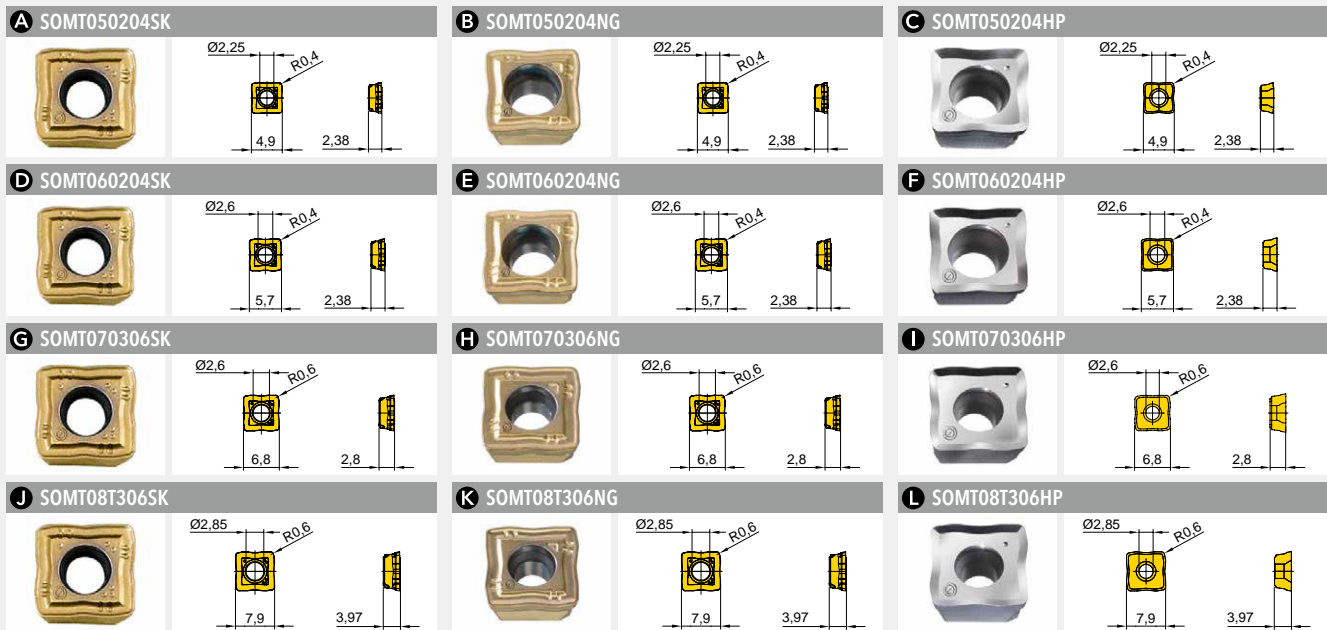

Artikel-Nr. Designation	fz(min/max)	Ausführung Design	Qualität Grade	IN10K	IN2505	IN2510	IN2530	IN6505			
SOMT050204SK ¹⁾	0,04/0,18	positive Geometrie R0,4 / positive geometry R0,4			●		●	●			
SOMT050204NG	0,06/0,15	Gussgeometrie R0,4 / cast iron geometry R0,4				●					
SOMT050204HP	0,06/0,15	NE-Geometrie, poliert R0,4 / non-ferrous geometry, polished R0,4	●								
SOMT060204SK ¹⁾	0,04/0,18	positive Geometrie R0,4 / positive geometry R0,4			●		●	●			
SOMT060204NG	0,06/0,15	Gussgeometrie R0,4 / cast iron geometry R0,4				●					
SOMT060204HP	0,06/0,15	NE-Geometrie, poliert R0,4 / non-ferrous geometry, polished R0,4	●								
SOMT070306SK ¹⁾	0,04/0,20	positive Geometrie R0,6 / positive geometry R0,6			●		●	●			
SOMT070306NG	0,08/0,16	Gussgeometrie R0,6 / cast iron geometry R0,6				●					
SOMT070306HP	0,08/0,16	NE-Geometrie, poliert R0,6 / non-ferrous geometry, polished R0,6	●								
SOMT08T306SK ¹⁾	0,04/0,20	positive Geometrie R0,6 / positive geometry R0,6			●		●	●			
SOMT08T306NG	0,08/0,16	Gussgeometrie R0,6 / cast iron geometry R0,6				●					
SOMT08T306HP	0,08/0,16	NE-Geometrie, poliert R0,6 / non-ferrous geometry, polished R0,6	●								

¹⁾ IN6505 nur als Umfangsschneide verwenden. / Use IN6505 grade only for peripheral inserts

● = P ● = M ● = K ● = N ● = S ○ = H

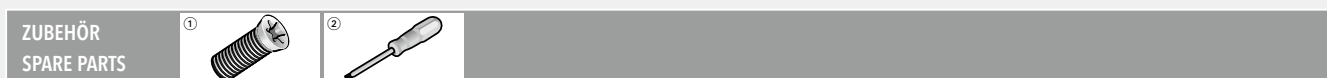

Durchmesserbereich / Diameter Range

14,0 - 16,0	SM20-043-00 (0,7Nm)	DS-TP06S (TX-Plus)
17,0 - 22,0	TS 22052I/HG-P (0,8Nm)	DS-TP07S (TX-Plus)
23,0 - 26,0	SO 25065I (1,1Nm)	DS-T07S

① = Spannschraube / Insert screw ② = Schraubendreher / Screw driver

AUFNAHME KOMPATIBEL MIT DIN 1835 B
ADAPTION ACC. TO DIN 1835 B

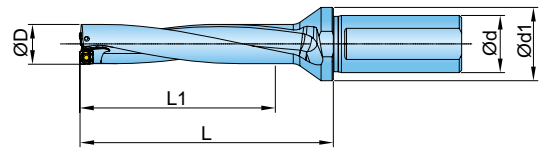

Artikel-Nr. Designation	D	d	d1	L	L1	Z	Zeff			Passende WSP Related Insert
QR0270135JFR00	27,0	25	40	158	135	2	1	✓	0,65	ABC
QR0280140JFR00	28,0	25	40	163	140	2	1	✓	0,68	ABC
QR0290145JGR00	29,0	32	40	168	145	2	1	✓	0,86	ABC
QR0300150JGR00	30,0	32	40	173	150	2	1	✓	1,04	ABC
QR0310155JGR00	31,0	32	40	178	155	2	1	✓	1,08	ABC
QR0320160JGR00	32,0	32	40	183	160	2	1	✓	1,14	DEF
QR0330165JGR00	33,0	32	40	188	165	2	1	✓	1,20	DEF
QR0340170JGR00	34,0	32	40	193	170	2	1	✓	1,26	DEF
QR0350175JGR00	35,0	32	40	198	175	2	1	✓	1,29	DEF
QR0360180JGR00	36,0	32	40	203	180	2	1	✓	1,39	DEF
QR0370185JGR00	37,0	32	50	213	185	2	1	✓	1,40	GHI
QR0380190JGR00	38,0	32	50	218	190	2	1	✓	1,50	GHI
QR0390195JGR00	39,0	32	50	223	195	2	1	✓	1,56	GHI
QR0400200JGR00	40,0	32	50	228	200	2	1	✓	1,68	GHI
QR0410205JHR00	41,0	40	50	233	205	2	1	✓	2,08	GHI
QR0420210JHR00	42,0	40	50	238	210	2	1	✓	2,16	GHI
QR0430215JHR00	43,0	40	50	243	215	2	1	✓	2,28	GHI
QR0440220JHR00	44,0	40	60	255	220	2	1	✓	2,36	JKL
QR0450225JHR00	45,0	40	60	260	225	2	1	✓	2,45	JKL
QR0460230JHR00	46,0	40	60	265	230	2	1	✓	2,56	JKL
QR0470235JHR00	47,0	40	60	270	235	2	1	✓	2,63	JKL
QR0480240JHR00	48,0	40	60	275	240	2	1	✓	2,73	JKL
QR0490245JHR00	49,0	40	60	280	245	2	1	✓	2,85	JKL
QR0500250JHR00	50,0	40	60	285	250	2	1	✓	2,95	JKL

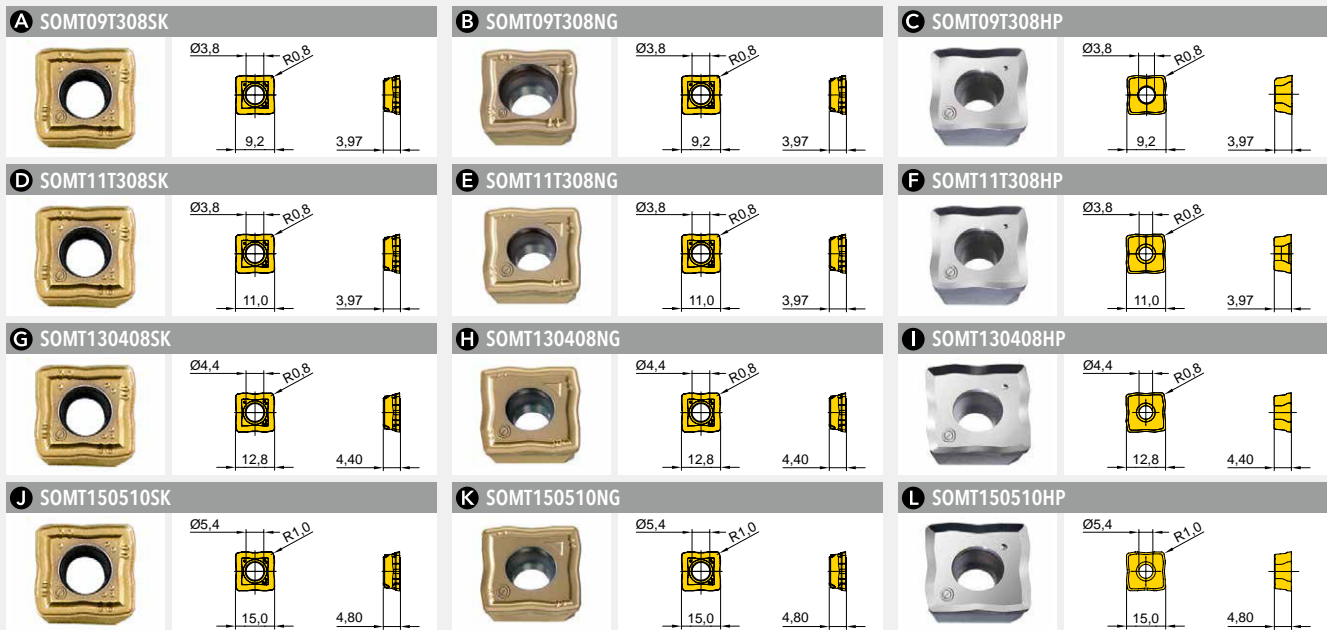

Artikel-Nr. Designation	fz(min/max)	Ausführung Design	Qualität Grade	IN10K	IN2505	IN2510	IN2530	IN6505			
SOMT09T308SK ¹⁾	0,06/0,20	positive Geometrie R0,8 / positive geometry R0,8			●		●	●			
SOMT09T308NG	0,08/0,18	Gussgeometrie R0,8 / cast iron geometry R0,8				●					
SOMT09T308HP	0,08/0,18	NE-Geometrie, poliert R0,8 / non-ferrous geometry, polished R0,8	●								
SOMT11T308SK ¹⁾	0,06/0,22	positive Geometrie R0,8 / positive geometry R0,8			●		●	●			
SOMT11T308NG	0,08/0,18	Gussgeometrie R0,8 / cast iron geometry R0,8				●					
SOMT11T308HP	0,08/0,18	NE-Geometrie, poliert R0,8 / non-ferrous geometry, polished R0,8	●								
SOMT130408SK ¹⁾	0,06/0,22	positive Geometrie R0,8 / positive geometry R0,8			●		●	●			
SOMT130408NG	0,10/0,18	Gussgeometrie R0,8 / cast iron geometry R0,8				●					
SOMT130408HP	0,10/0,18	NE-Geometrie, poliert R0,8 / non-ferrous geometry, polished R0,8	●								
SOMT150510SK ¹⁾	0,06/0,24	positive Geometrie R1,0 / positive geometry R1,0			●		●	●			
SOMT150510NG	0,10/0,18	Gussgeometrie R1,0 / cast iron geometry R1,0				●					
SOMT150510HP	0,10/0,18	NE-Geometrie, poliert R1,0 / non-ferrous geometry, polished R1,0	●								

¹⁾ IN6505 nur als Umfangsschneide verwenden. / Use IN6505 grade only for peripheral inserts

● = P ● = M ● = K ● = N ● = S ○ = H

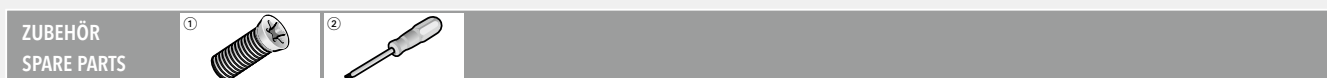

Durchmesserbereich / Diameter Range

27,0 - 36,0	SM35-088-60 (3,0Nm) DS-T10S
37,0 - 43,0	SM40-093-20 (4,5Nm) DS-T15S
44,0 - 50,0	SM50-113-20 (8,0Nm) DS-T20S

① = Spannschraube / Insert screw ② = Schraubendreher / Screw driver

AUFNAHME KOMPATIBEL MIT DIN 1835 B
 ADAPTION ACC. TO DIN 1835 B

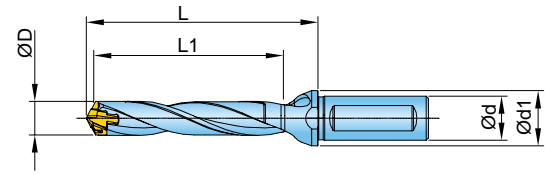

Artikel-Nr. Designation	D min.	D max.	d	d1	L	L1	Bs	Schlüssel / Wrench	IK	kg
TD0600009JCR00	6,0	6,4	12	16	23,0	9	6	KTD6.0-9.9	✓	0,02
TD0650010JCR00	6,5	6,9	12	16	24,0	10	6	KTD6.0-9.9	✓	0,02
TD0700011JCR00	7,0	7,4	12	16	25,1	11	7	KTD6.0-9.9	✓	0,03
TD0750011JCR00	7,5	7,9	12	16	25,9	11,3	7	KTD6.0-9.9	✓	0,03
TD0800012JCR00	8,0	8,9	12	16	27,9	12	8	KTD6.0-9.9	✓	0,04
TD0900014JCR00	9,0	9,9	12	16	29,3	14	9	KTD6.0-9.9	✓	0,05
TD1000015JDR00	10,0	10,9	16	20	31,2	15	10	KTD10.0-19.9	✓	0,08
TD1100017JDR00	11,0	11,9	16	20	33,1	17	11	KTD10.0-19.9	✓	0,09
TD1200018JDR00	12,0	12,9	16	20	35,0	18	12	KTD10.0-19.9	✓	0,10
TD1300020JDR00	13,0	13,9	16	20	37,1	20	13	KTD10.0-19.9	✓	0,11
TD1400021JDR00	14,0	14,9	16	20	41,1	21	14	KTD10.0-19.9	✓	0,12
TD1500023JER00	15,0	15,9	20	25	46,2	23	15	KTD10.0-19.9	✓	0,15
TD1600024JER00	16,0	16,9	20	25	49,3	24	16	KTD10.0-19.9	✓	0,16
TD1700026JER00	17,0	17,9	20	25	52,4	26	17	KTD10.0-19.9	✓	0,17
TD1800027JFR00	18,0	18,9	25	32	55,5	27	18	KTD10.0-19.9	✓	0,28
TD1900029JFR00	19,0	19,9	25	32	58,5	29	19	KTD10.0-19.9	✓	0,30
TD2000030JFR00	20,0	20,9	25	32	61,6	30	20	KTD20.0-26.9	✓	0,31
TD2100032JFR00	21,0	21,9	25	32	64,7	32	21	KTD20.0-26.9	✓	0,32
TD2200033JFR00	22,0	22,9	25	32	67,8	33	22	KTD20.0-26.9	✓	0,34
TD2300035JGR00	23,0	23,9	32	42	70,9	35	23	KTD20.0-26.9	✓	0,42
TD2400036JGR00	24,0	24,9	32	42	74,0	36	24	KTD20.0-26.9	✓	0,46
TD2500038JGR00	25,0	25,9	32	42	77,0	38	25	KTD20.0-26.9	✓	0,50

AUFNAHME KOMPATIBEL MIT DIN 1835 B
 ADAPTION ACC. TO DIN 1835 B

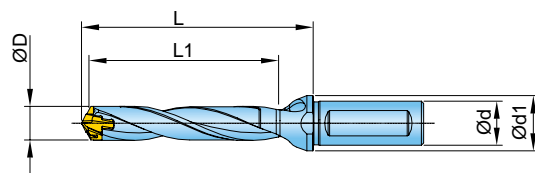

Artikel-Nr. Designation	D min.	D max.	d	d1	L	L1	Bs	Schlüssel / Wrench		
TD0600018JCR00	6,0	6,4	12	16	32,0	18	6	KTD6.0-9.9	✓	0,03
TD0650020JCR00	6,5	6,9	12	16	34,0	20	6	KTD6.0-9.9	✓	0,03
TD0700021JCR00	7,0	7,4	12	16	35,6	21	7	KTD6.0-9.9	✓	0,04
TD0750023JCR00	7,5	7,9	12	16	37,1	23	7	KTD6.0-9.9	✓	0,04
TD0800024JCR00	8,0	8,4	12	16	39,4	24	8	KTD6.0-9.9	✓	0,05
TD0850026JCR00	8,5	8,9	12	16	40,9	26	8	KTD6.0-9.9	✓	0,05
TD0900027JCR00	9,0	9,4	12	16	42,8	27	9	KTD6.0-9.9	✓	0,06
TD0950029JCR00	9,5	9,9	12	16	44,3	29	9	KTD6.0-9.9	✓	0,06
TD1000030JDR00	10,0	10,4	16	20	46,2	30	10	KTD10.0-19.9	✓	0,09
TD1050032JDR00	10,5	10,9	16	20	47,7	32	10	KTD10.0-19.9	✓	0,10
TD1100033JDR00	11,0	11,4	16	20	49,6	33	11	KTD10.0-19.9	✓	0,10
TD1150035JDR00	11,5	11,9	16	20	51,1	35	11	KTD10.0-19.9	✓	0,11
TD1200036JDR00	12,0	12,4	16	20	53,0	36	12	KTD10.0-19.9	✓	0,11
TD1250037JDR00	12,5	12,9	16	20	54,5	37	12	KTD10.0-19.9	✓	0,11
TD1300039JDR00	13,0	13,4	16	20	56,6	39	13	KTD10.0-19.9	✓	0,12
TD1350041JDR00	13,5	13,9	16	20	58,1	41	13	KTD10.0-19.9	✓	0,12
TD1400042JDR00	14,0	14,4	16	20	62,1	42	14	KTD10.0-19.9	✓	0,13
TD1450044JDR00	14,5	14,9	16	20	63,6	44	14	KTD10.0-19.9	✓	0,13
TD1500045JER00	15,0	15,9	20	25	68,7	45	15	KTD10.0-19.9	✓	0,18
TD1600048JER00	16,0	16,9	20	25	73,3	48	16	KTD10.0-19.9	✓	0,19
TD1700051JER00	17,0	17,9	20	25	77,9	51	17	KTD10.0-19.9	✓	0,20
TD1800054JFR00	18,0	18,9	25	32	82,5	54	18	KTD10.0-19.9	✓	0,32
TD1900057JFR00	19,0	19,9	25	32	87,0	57	19	KTD10.0-19.9	✓	0,34
TD2000060JFR00	20,0	20,9	25	32	91,6	60	20	KTD20.0-26.9	✓	0,35
TD2100063JFR00	21,0	21,9	25	32	96,2	63	21	KTD20.0-26.9	✓	0,36
TD2200066JFR00	22,0	22,9	25	32	100,8	66	22	KTD20.0-26.9	✓	0,37
TD2300069JGR00	23,0	23,9	32	42	105,4	69	23	KTD20.0-26.9	✓	0,45
TD2400072JGR00	24,0	24,9	32	42	109,9	72	24	KTD20.0-26.9	✓	0,49
TD2500075JGR00	25,0	25,9	32	42	114,5	75	25	KTD20.0-26.9	✓	0,53

AUFNAHME KOMPATIBEL MIT DIN 1835 B
 ADAPTION ACC. TO DIN 1835 B

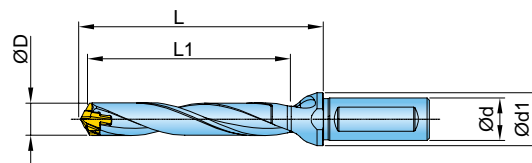

Artikel-Nr. Designation	D min.	D max.	d	d1	L	L1	Bs	Schlüssel / Wrench	IK	kg
TD0600030JCR00	6,0	6,4	12	16	44,0	30	6	KTD6.0-9.9	✓	0,04
TD0650033JCR00	6,5	6,9	12	16	47,0	33	6	KTD6.0-9.9	✓	0,04
TD0700035JCR00	7,0	7,4	12	16	49,6	35	7	KTD6.0-9.9	✓	0,05
TD0750038JCR00	7,5	7,9	12	16	52,1	38	7	KTD6.0-9.9	✓	0,05
TD0800040JCR00	8,0	8,4	12	16	55,4	40	8	KTD6.0-9.9	✓	0,06
TD0850043JCR00	8,5	8,9	12	16	57,9	43	8	KTD6.0-9.9	✓	0,06
TD0900045JCR00	9,0	9,4	12	16	60,8	45	9	KTD6.0-9.9	✓	0,07
TD0950048JCR00	9,5	9,9	12	16	63,3	48	9	KTD6.0-9.9	✓	0,07
TD1000050JDR00	10,0	10,4	16	20	66,2	50	10	KTD10.0-19.9	✓	0,10
TD1050053JDR00	10,5	10,9	16	20	68,7	53	10	KTD10.0-19.9	✓	0,11
TD1100055JDR00	11,0	11,4	16	20	71,6	55	11	KTD10.0-19.9	✓	0,11
TD1150058JDR00	11,5	11,9	16	20	74,1	58	11	KTD10.0-19.9	✓	0,12
TD1200060JDR00	12,0	12,4	16	20	77,0	60	12	KTD10.0-19.9	✓	0,12
TD1250062JDR00	12,5	12,9	16	20	79,5	62	12	KTD10.0-19.9	✓	0,12
TD1300065JDR00	13,0	13,4	16	20	82,6	65	13	KTD10.0-19.9	✓	0,13
TD1350068JDR00	13,5	13,9	16	20	85,1	68	13	KTD10.0-19.9	✓	0,13
TD1400070JDR00	14,0	14,4	16	20	90,2	70	14	KTD10.0-19.9	✓	0,14
TD1450073JDR00	14,5	14,9	16	20	92,7	73	14	KTD10.0-19.9	✓	0,15
TD1500075JER00	15,0	15,9	20	25	98,7	75	15	KTD10.0-19.9	✓	0,21
TD1600080JER00	16,0	16,9	20	25	105,3	80	16	KTD10.0-19.9	✓	0,22
TD1700085JER00	17,0	17,9	20	25	111,9	85	17	KTD10.0-19.9	✓	0,23
TD1800090JFR00	18,0	18,9	25	32	118,5	90	18	KTD10.0-19.9	✓	0,36
TD1900095JFR00	19,0	19,9	25	32	125,0	95	19	KTD10.0-19.9	✓	0,38
TD2000100JFR00	20,0	20,9	25	32	131,6	100	20	KTD20.0-26.9	✓	0,39
TD2100105JFR00	21,0	21,9	25	32	138,2	105	21	KTD20.0-26.9	✓	0,40
TD2200110JFR00	22,0	22,9	25	32	144,8	110	22	KTD20.0-26.9	✓	0,43
TD2300115JGR00	23,0	23,9	32	42	151,4	115	23	KTD20.0-26.9	✓	0,56
TD2400120JGR00	24,0	24,9	32	42	158,0	120	24	KTD20.0-26.9	✓	0,60
TD2500125JGR00	25,0	25,9	32	42	164,5	125	25	KTD20.0-26.9	✓	0,65

AUFNAHME KOMPATIBEL MIT DIN 1835 B
 ADAPTION ACC. TO DIN 1835 B

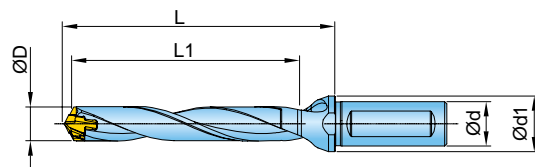

Artikel-Nr. Designation	D min.	D max.	d	d1	L	L1	Bs	Schlüssel / Wrench		
TD0700056JCR00	7,0	7,4	12	16	70,6	56	7	KTD6.0-9.9	✓	0,06
TD0750058JCR00	7,5	7,9	12	16	74,6	58	7	KTD6.0-9.9	✓	0,06
TD0800064JCR00	8,0	8,4	12	16	79,4	64	8	KTD6.0-9.9	✓	0,07
TD0850068JCR00	8,5	8,9	12	16	84,4	68	8	KTD6.0-9.9	✓	0,07
TD0900072JCR00	9,0	9,4	12	16	87,8	72	9	KTD6.0-9.9	✓	0,08
TD0950076JCR00	9,5	9,9	12	16	92,7	76	9	KTD6.0-9.9	✓	0,08
TD1000080JDR00	10,0	10,4	16	20	96,2	80	10	KTD10.0-19.9	✓	0,11
TD1050084JDR00	10,5	10,9	16	20	100,2	84	10	KTD10.0-19.9	✓	0,12
TD1100088JDR00	11,0	11,4	16	20	104,6	88	11	KTD10.0-19.9	✓	0,12
TD1150092JDR00	11,5	11,9	16	20	108,6	92	11	KTD10.0-19.9	✓	0,13
TD1200096JDR00	12,0	12,4	16	20	113,0	96	12	KTD10.0-19.9	✓	0,13
TD1250100JDR00	12,5	12,9	16	20	117,0	100	12	KTD10.0-19.9	✓	0,13
TD1300104JDR00	13,0	13,4	16	20	121,6	104	13	KTD10.0-19.9	✓	0,14
TD1350108JDR00	13,5	13,9	16	20	125,6	108	13	KTD10.0-19.9	✓	0,15
TD1400112JDR00	14,0	14,4	16	20	132,1	112	14	KTD10.0-19.9	✓	0,16
TD1450116JDR00	14,5	14,9	16	20	136,2	116	14	KTD10.0-19.9	✓	0,18
TD1500120JER00	15,0	15,9	20	25	143,7	120	15	KTD10.0-19.9	✓	0,24
TD1600128JER00	16,0	16,9	20	25	153,3	128	16	KTD10.0-19.9	✓	0,26
TD1700136JER00	17,0	17,9	20	25	162,9	136	17	KTD10.0-19.9	✓	0,28
TD1800144JFR00	18,0	18,9	25	32	172,5	144	18	KTD10.0-19.9	✓	0,42
TD1900152JFR00	19,0	19,9	25	32	182,0	152	19	KTD10.0-19.9	✓	0,45
TD2000160JFR00	20,0	20,9	25	32	191,6	160	20	KTD20.0-26.9	✓	0,48
TD2100168JFR00	21,0	21,9	25	32	201,2	168	21	KTD20.0-26.9	✓	0,55
TD2200176JFR00	22,0	22,9	25	32	210,8	176	22	KTD20.0-26.9	✓	0,61
TD2300184JGR00	23,0	23,9	32	42	220,4	184	23	KTD20.0-26.9	✓	0,68
TD2400192JGR00	24,0	24,9	32	42	230,0	192	24	KTD20.0-26.9	✓	0,72
TD2500200JGR00	25,0	25,9	32	42	239,5	200	25	KTD20.0-26.9	✓	0,76

Pilotbohrung wird empfohlen! /

AUFNAHME KOMPATIBEL MIT DIN 1835 A
 ADAPTION ACC. TO DIN 1835 A

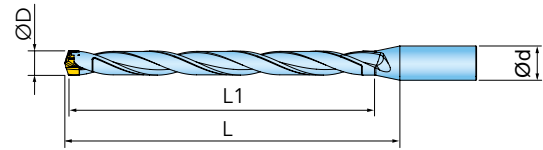

Artikel-Nr. Designation	D min.	D max.	d	L	L1	Bs	Schlüssel / Wrench	IK	kg
TD1200144T3R00	12,0	12,4	16	161	144	12	KTD10.0-19.9	✓	0,14
TD1250150T3R00	12,5	12,9	16	167	150	12	KTD10.0-19.9	✓	0,14
TD1300156T3R00	13,0	13,4	16	173	156	13	KTD10.0-19.9	✓	0,15
TD1350162T3R00	13,5	13,9	16	179	162	13	KTD10.0-19.9	✓	0,15
TD1400168T3R00	14,0	14,4	16	188	168	14	KTD10.0-19.9	✓	0,17
TD1450174T3R00	14,5	14,9	16	194	174	14	KTD10.0-19.9	✓	0,20
TD1500180T4R00	15,0	15,9	20	210	180	15	KTD10.0-19.9	✓	0,27
TD1600192T4R00	16,0	16,9	20	224	192	16	KTD10.0-19.9	✓	0,30
TD1700204T4R00	17,0	17,9	20	238	204	17	KTD10.0-19.9	✓	0,32
TD1800216T5R00	18,0	18,9	25	252	216	18	KTD10.0-19.9	✓	0,48
TD1900228T5R00	19,0	19,9	25	266	228	19	KTD10.0-19.9	✓	0,52
TD2000240T5R00	20,0	20,9	25	280	240	20	KTD20.0-26.9	✓	0,57
TD2100252T5R00	21,0	21,9	25	294	252	21	KTD20.0-26.9	✓	0,65
TD2200264T5R00	22,0	22,9	25	308	264	22	KTD20.0-26.9	✓	0,75
TD2300276U7R00	23,0	23,9	32	312	286	23	KTD20.0-26.9	✓	0,82
TD2400288U7R00	24,0	24,9	32	326	288	24	KTD20.0-26.9	✓	0,86
TD2500300U7R00	25,0	25,9	32	340	300	25	KTD20.0-26.9	✓	0,90

Pilotbohrung wird empfohlen! / Pilot hole is recommended!

AUFNAHME KOMPATIBEL MIT DIN 1835 B
 ADAPTION ACC. TO DIN 1835 B

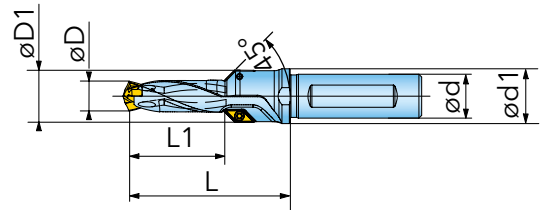

Artikel-Nr. Designation	D min.	D max.	D1	d	d1	L	L1	Bs	Schlüssel / Wrench		
TC0680021JCR01	6,5	6,9	13,5	12	16	45	21	6	KTD6.0-9.9	✓	0,06
TC0850026JCR01	8,5	8,9	15,5	12	16	50	26	8	KTD6.0-9.9	✓	0,07
TC1020030JDR01	10,0	10,4	17	16	20	54	30	10	KTD10.0-19.9	✓	0,08
TC1200035JDR01	12,0	12,4	19	16	20	61	35	12	KTD10.0-19.9	✓	0,10
TC1400039JER01	14,0	14,4	21	20	25	69	39	14	KTD10.0-19.9	✓	0,16
TC1750042JER01	17,0	17,9	24,5	20	27	72	42	17	KTD10.0-19.9	✓	0,23
TC2100048JFR01	21,0	21,9	28	25	32	80	48	21	KTD20.0-26.9	✓	0,30

KOMT050104R

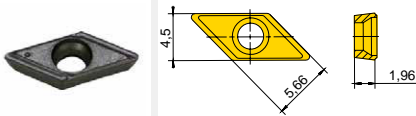

Artikel-Nr. Designation	fz(min/max)	Ausführung Design	Qualität Grade	IN2005	IN2505						
KOMT050104R	0,08/0,20	Fas-Geometrie / chamfering geometry									

● = P ● = M ● = K ● = N ● = S ○ = H

ZUBEHÖR
 SPARE PARTS



SM22-046-00

DS-T07S

① = Spannschraube / Insert screw ② = Schraubendreher / Screw driver

BOHRKÖPFE FÜR GOLDTWIST
BORING HEADS FOR GOLDTWIST

Aluminium Bearbeitung /
Machining of aluminum

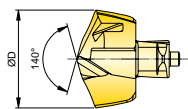

Guss Bearbeitung /
Machining of cast iron

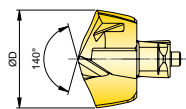

rostfreier Stahl Bearbeitung /
Machining of stainless steel

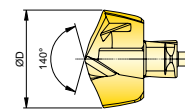

Stahl Bearbeitung /
Machining of steel

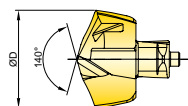

doppelte Führungsfase Bearbeitung /
Machining with double margin

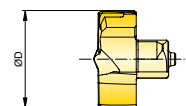

flacher Grund (1,5xD/3xD/5xD) Bearbeitung /
Flat bottom (1,5xD/3xD/5xD) machining

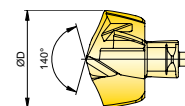

D	Artikel-Nr. / Designation				doppelte Führungsfase / Double margin	flacher Grund / Flat bottom	Qualität / Grade
	Aluminium / Aluminum	Guss / Cast iron	rostfreier Stahl / Stainless steel	Stahl / Steel			
6,0	TNA0600R01						IN 05S
6,0		TKA0600R01	TMA0600R01	TPA0600R01			IN 2505
6,1		TKA0610R01	TMA0610R01	TPA0610R01			IN 2505
6,2		TKA0620R01	TMA0620R01	TPA0620R01			IN 2505
6,3		TKA0630R01	TMA0630R01	TPA0630R01			IN 2505
6,4		TKA0640R01	TMA0640R01	TPA0640R01			IN 2505
6,5	TNA0650R01						IN 05S
6,5		TKA0650R01	TMA0650R01	TPA0650R01			IN 2505
6,6		TKA0660R01	TMA0660R01	TPA0660R01			IN 2505
6,7		TKA0670R01	TMA0670R01	TPA0670R01			IN 2505
6,8	TNA0680R01						IN 05S
6,8		TKA0680R01	TMA0680R01	TPA0680R01			IN 2505
6,9		TKA0690R01	TMA0690R01	TPA0690R01			IN 2505
7,0	TNA0700R01						IN 05S
7,0		TKA0700R01	TMA0700R01	TPA0700R01	TPF0700R01		IN 2505
7,1		TKA0710R01	TMA0710R01	TPA0710R01			IN 2505
7,2		TKA0720R01	TMA0720R01	TPA0720R01			IN 2505
7,3		TKA0730R01	TMA0730R01	TPA0730R01			IN 2505
7,4		TKA0740R01	TMA0740R01	TPA0740R01			IN 2505
7,5	TNA0750R01						IN 05S
7,5		TKA0750R01	TMA0750R01	TPA0750R01	TPF0750R01		IN 2505
7,6		TKA0760R01	TMA0760R01	TPA0760R01			IN 2505
7,7		TKA0770R01	TMA0770R01	TPA0770R01			IN 2505
7,8		TKA0780R01	TMA0780R01	TPA0780R01			IN 2505
7,9		TKA0790R01	TMA0790R01	TPA0790R01			IN 2505
8,0	TNA0800R01						IN 05S
8,0		TKA0800R01	TMA0800R01	TPA0800R01	TPF0800R01	TPA0800R01-M2	IN 2505
8,1		TKA0810R01	TMA0810R01	TPA0810R01			IN 2505
8,2		TKA0820R01	TMA0820R01	TPA0820R01			IN 2505
8,3		TKA0830R01	TMA0830R01	TPA0830R01			IN 2505
8,4		TKA0840R01	TMA0840R01	TPA0840R01			IN 2505
8,5	TNA0850R01						IN 05S
8,5		TKA0850R01	TMA0850R01	TPA0850R01	TPF0850R01	TPA0850R01-M2	IN 2505
8,6		TKA0860R01	TMA0860R01	TPA0860R01			IN 2505
8,7		TKA0870R01	TMA0870R01	TPA0870R01			IN 2505
8,8		TKA0880R01	TMA0880R01	TPA0880R01			IN 2505
8,9		TKA0890R01	TMA0890R01	TPA0890R01			IN 2505
9,0	TNA0900R01						IN 05S
9,0		TKA0900R01	TMA0900R01	TPA0900R01	TPF0900R01	TPA0900R01-M2	IN 2505
9,1		TKA0910R01	TMA0910R01	TPA0910R01			IN 2505

**BOHRKÖPFE FÜR GOLDTWIST
BORING HEADS FOR GOLDTWIST**

D	Artikel-Nr. / Designation				doppelte Führungsfase / Double margin	flacher Grund / Flat bottom	Qualität / Grade
	Aluminium / Aluminum	Guss / Cast iron	rostfreier Stahl / Stainless steel	Stahl / Steel			
9,2		TKA0920R01	TMA0920R01	TPA0920R01			IN 2505
9,3		TKA0930R01	TMA0930R01	TPA0930R01			IN 2505
9,4		TKA0940R01	TMA0940R01	TPA0940R01			IN 2505
9,5	TNA0950R01						IN 05S
9,5		TKA0950R01	TMA0950R01	TPA0950R01	TPF0950R01	TPA0950R01-M2	IN 2505
9,6		TKA0960R01	TMA0960R01	TPA0960R01			IN 2505
9,7		TKA0970R01	TMA0970R01	TPA0970R01			IN 2505
9,8		TKA0980R01	TMA0980R01	TPA0980R01			IN 2505
9,9		TKA0990R01	TMA0990R01	TPA0990R01			IN 2505
10,0	TNA1000R01						IN 05S
10,0		TKA1000R01	TMA1000R01	TPA1000R01	TPF1000R01	TPA1000R01-M2	IN 2505
10,1		TKA1010R01	TMA1010R01	TPA1010R01			IN 2505
10,2	TNA1020R01						IN 05S
10,2		TKA1020R01	TMA1020R01	TPA1020R01			IN 2505
10,3		TKA1030R01	TMA1030R01	TPA1030R01			IN 2505
10,4		TKA1040R01	TMA1040R01	TPA1040R01			IN 2505
10,5	TNA1050R01						IN 05S
10,5		TKA1050R01	TMA1050R01	TPA1050R01	TPF1050R01	TPA1050R01-M2	IN 2505
10,6		TKA1060R01	TMA1060R01	TPA1060R01			IN 2505
10,7		TKA1070R01	TMA1070R01	TPA1070R01			IN 2505
10,8		TKA1080R01	TMA1080R01	TPA1080R01			IN 2505
10,9		TKA1090R01	TMA1090R01	TPA1090R01			IN 2505
11,0	TNA1100R01						IN 05S
11,0		TKA1100R01	TMA1100R01	TPA1100R01	TPF1100R01	TPA1100R01-M2	IN 2505
11,1		TKA1110R01	TMA1110R01	TPA1110R01			IN 2505
11,2		TKA1120R01	TMA1120R01	TPA1120R01			IN 2505
11,3		TKA1130R01	TMA1130R01	TPA1130R01			IN 2505
11,4		TKA1140R01	TMA1140R01	TPA1140R01			IN 2505
11,5	TNA1150R01						IN 05S
11,5		TKA1150R01	TMA1150R01	TPA1150R01	TPF1150R01	TPA1150R01-M2	IN 2505
11,6		TKA1160R01	TMA1160R01	TPA1160R01			IN 2505
11,7		TKA1170R01	TMA1170R01	TPA1170R01			IN 2505
11,8		TKA1180R01	TMA1180R01	TPA1180R01			IN 2505
11,9		TKA1190R01	TMA1190R01	TPA1190R01			IN 2505
12,0	TNA1200R01						IN 05S
12,0		TKA1200R01	TMA1200R01	TPA1200R01	TPF1200R01	TPA1200R01-M2	IN 2505
12,1		TKA1210R01	TMA1210R01	TPA1210R01			IN 2505
12,2		TKA1220R01	TMA1220R01	TPA1220R01			IN 2505
12,3		TKA1230R01	TMA1230R01	TPA1230R01			IN 2505
12,4		TKA1240R01	TMA1240R01	TPA1240R01			IN 2505
12,5	TNA1250R01						IN 05S
12,5		TKA1250R01	TMA1250R01	TPA1250R01	TPF1250R01	TPA1250R01-M2	IN 2505
12,6		TKA1260R01	TMA1260R01	TPA1260R01			IN 2505
12,7		TKA1270R01	TMA1270R01	TPA1270R01			IN 2505
12,8		TKA1280R01	TMA1280R01	TPA1280R01			IN 2505
12,9		TKA1290R01	TMA1290R01	TPA1290R01			IN 2505
13,0	TNA1300R01						IN 05S
13,0		TKA1300R01	TMA1300R01	TPA1300R01	TPF1300R01	TPA1300R01-M2	IN 2505
13,1		TKA1310R01	TMA1310R01	TPA1310R01			IN 2505
13,2		TKA1320R01	TMA1320R01	TPA1320R01			IN 2505

**BOHRKÖPFE FÜR GOLDTWIST
BORING HEADS FOR GOLDTWIST**

D	Artikel-Nr. / Designation				doppelte Führungsfase / Double margin	flacher Grund / Flat bottom	Qualität / Grade
	Aluminium / Aluminum	Guss / Cast iron	rostfreier Stahl / Stainless steel	Stahl / Steel			
13,3		TKA1330R01	TMA1330R01	TPA1330R01			IN 2505
13,4		TKA1340R01	TMA1340R01	TPA1340R01			IN 2505
13,5	TNA1350R01						IN 05S
13,5		TKA1350R01	TMA1350R01	TPA1350R01	TPF1350R01	TPA1350R01-M2	IN 2505
13,6		TKA1360R01	TMA1360R01	TPA1360R01			IN 2505
13,7		TKA1370R01	TMA1370R01	TPA1370R01			IN 2505
13,8		TKA1380R01	TMA1380R01	TPA1380R01			IN 2505
13,9		TKA1390R01	TMA1390R01	TPA1390R01			IN 2505
14,0	TNA1400R01						IN 05S
14,0		TKA1400R01	TMA1400R01	TPA1400R01	TPF1400R01	TPA1400R01-M2	IN 2505
14,1		TKA1410R01	TMA1410R01	TPA1410R01			IN 2505
14,2		TKA1420R01	TMA1420R01	TPA1420R01			IN 2505
14,3		TKA1430R01	TMA1430R01	TPA1430R01			IN 2505
14,4		TKA1440R01	TMA1440R01	TPA1440R01			IN 2505
14,5	TNA1450R01						IN 05S
14,5		TKA1450R01	TMA1450R01	TPA1450R01	TPF1450R01	TPA1450R01-M2	IN 2505
14,6		TKA1460R01	TMA1460R01	TPA1460R01			IN 2505
14,7		TKA1470R01	TMA1470R01	TPA1470R01			IN 2505
14,8		TKA1480R01	TMA1480R01	TPA1480R01			IN 2505
14,9		TKA1490R01	TMA1490R01	TPA1490R01			IN 2505
15,0	TNA1500R01						IN 05S
15,0		TKA1500R01	TMA1500R01	TPA1500R01	TPF1500R01	TPA1500R01-M2	IN 2505
15,1		TKA1510R01	TMA1510R01	TPA1510R01			IN 2505
15,2		TKA1520R01	TMA1520R01	TPA1520R01			IN 2505
15,3		TKA1530R01	TMA1530R01	TPA1530R01			IN 2505
15,4		TKA1540R01	TMA1540R01	TPA1540R01			IN 2505
15,5	TNA1550R01						IN 05S
15,5		TKA1550R01	TMA1550R01	TPA1550R01	TPF1550R01	TPA1550R01-M2	IN 2505
15,6		TKA1560R01	TMA1560R01	TPA1560R01			IN 2505
15,7		TKA1570R01	TMA1570R01	TPA1570R01			IN 2505
15,8		TKA1580R01	TMA1580R01	TPA1580R01			IN 2505
15,9		TKA1590R01	TMA1590R01	TPA1590R01			IN 2505
16,0	TNA1600R01						IN 05S
16,0		TKA1600R01	TMA1600R01	TPA1600R01	TPF1600R01	TPA1600R01-M2	IN 2505
16,1		TKA1610R01	TMA1610R01	TPA1610R01			IN 2505
16,2		TKA1620R01	TMA1620R01	TPA1620R01			IN 2505
16,3		TKA1630R01	TMA1630R01	TPA1630R01			IN 2505
16,4		TKA1640R01	TMA1640R01	TPA1640R01			IN 2505
16,5	TNA1650R01						IN 05S
16,5		TKA1650R01	TMA1650R01	TPA1650R01	TPF1650R01	TPA1650R01-M2	IN 2505
16,6		TKA1660R01	TMA1660R01	TPA1660R01			IN 2505
16,7		TKA1670R01	TMA1670R01	TPA1670R01			IN 2505
16,8		TKA1680R01	TMA1680R01	TPA1680R01			IN 2505
16,9		TKA1690R01	TMA1690R01	TPA1690R01			IN 2505
17,0	TNA1700R01						IN 05S
17,0		TKA1700R01	TMA1700R01	TPA1700R01	TPF1700R01	TPA1700R01-M2	IN 2505
17,1		TKA1710R01	TMA1710R01	TPA1710R01			IN 2505
17,2		TKA1720R01	TMA1720R01	TPA1720R01			IN 2505
17,3		TKA1730R01	TMA1730R01	TPA1730R01			IN 2505
17,4		TKA1740R01	TMA1740R01	TPA1740R01			IN 2505

**BOHRKÖPFE FÜR GOLDTWIST
BORING HEADS FOR GOLDTWIST**

D	Artikel-Nr. / Designation						Qualität / Grade
	Aluminium / Aluminum	Guss / Cast iron	rostfreier Stahl / Stainless steel	Stahl / Steel	doppelte Führungsfase / Double margin	flacher Grund / Flat bottom	
17,5	TNA1750R01						IN 05S
17,5		TKA1750R01	TMA1750R01	TPA1750R01	TPF1750R01	TPA1750R01-M2	IN 2505
17,6		TKA1760R01	TMA1760R01	TPA1760R01			IN 2505
17,7		TKA1770R01	TMA1770R01	TPA1770R01			IN 2505
17,8		TKA1780R01	TMA1780R01	TPA1780R01			IN 2505
17,9		TKA1790R01	TMA1790R01	TPA1790R01			IN 2505
18,0	TNA1800R01						IN 05S
18,0		TKA1800R01	TMA1800R01	TPA1800R01	TPF1800R01	TPA1800R01-M2	IN 2505
18,1		TKA1810R01	TMA1810R01	TPA1810R01			IN 2505
18,2		TKA1820R01	TMA1820R01	TPA1820R01			IN 2505
18,3		TKA1830R01	TMA1830R01	TPA1830R01			IN 2505
18,4		TKA1840R01	TMA1840R01	TPA1840R01			IN 2505
18,5	TNA1850R01						IN 05S
18,5		TKA1850R01	TMA1850R01	TPA1850R01	TPF1850R01	TPA1850R01-M2	IN 2505
18,6		TKA1860R01	TMA1860R01	TPA1860R01			IN 2505
18,7		TKA1870R01	TMA1870R01	TPA1870R01			IN 2505
18,8		TKA1880R01	TMA1880R01	TPA1880R01			IN 2505
18,9		TKA1890R01	TMA1890R01	TPA1890R01			IN 2505
19,0	TNA1900R01						IN 05S
19,0		TKA1900R01	TMA1900R01	TPA1900R01	TPF1900R01	TPA1900R01-M2	IN 2505
19,1		TKA1910R01	TMA1910R01	TPA1910R01			IN 2505
19,2		TKA1920R01	TMA1920R01	TPA1920R01			IN 2505
19,3		TKA1930R01	TMA1930R01	TPA1930R01			IN 2505
19,4		TKA1940R01	TMA1940R01	TPA1940R01			IN 2505
19,5	TNA1950R01						IN 05S
19,5		TKA1950R01	TMA1950R01	TPA1950R01	TPF1950R01	TPA1950R01-M2	IN 2505
19,6		TKA1960R01	TMA1960R01	TPA1960R01			IN 2505
19,7		TKA1970R01	TMA1970R01	TPA1970R01			IN 2505
19,8		TKA1980R01	TMA1980R01	TPA1980R01			IN 2505
19,9		TKA1990R01	TMA1990R01	TPA1990R01			IN 2505
20,0	TNA2000R01						IN 05S
20,0		TKA2000R01	TMA2000R01	TPA2000R01	TPF2000R01		IN 2505
20,1		TKA2010R01	TMA2010R01	TPA2010R01			IN 2505
20,2		TKA2020R01	TMA2020R01	TPA2020R01			IN 2505
20,3		TKA2030R01	TMA2030R01	TPA2030R01			IN 2505
20,4		TKA2040R01	TMA2040R01	TPA2040R01			IN 2505
20,5	TNA2050R01						IN 05S
20,5		TKA2050R01	TMA2050R01	TPA2050R01	TPF2050R01		IN 2505
20,6		TKA2060R01	TMA2060R01	TPA2060R01			IN 2505
20,7		TKA2070R01	TMA2070R01	TPA2070R01			IN 2505
20,8		TKA2080R01	TMA2080R01	TPA2080R01			IN 2505
20,9		TKA2090R01	TMA2090R01	TPA2090R01			IN 2505
21,0	TNA2100R01						IN 05S
21,0		TKA2100R01	TMA2100R01	TPA2100R01	TPF2100R01		IN 2505
21,1		TKA2110R01	TMA2110R01	TPA2110R01			IN 2505
21,2		TKA2120R01	TMA2120R01	TPA2120R01			IN 2505
21,3		TKA2130R01	TMA2130R01	TPA2130R01			IN 2505
21,4		TKA2140R01	TMA2140R01	TPA2140R01			IN 2505
21,5	TNA2150R01						IN 05S
21,5		TKA2150R01	TMA2150R01	TPA2150R01	TPF2150R01		IN 2505

**BOHRKÖPFE FÜR GOLDTWIST
BORING HEADS FOR GOLDTWIST**

D	Artikel-Nr. / Designation						
	Aluminium / Aluminum	Guss / Cast iron	rostfreier Stahl / Stainless steel	Stahl / Steel	doppelte Führungsfase / Double margin	flacher Grund / Flat bottom	Qualität / Grade
21,6		TKA2160R01	TMA2160R01	TPA2160R01			IN 2505
21,7		TKA2170R01	TMA2170R01	TPA2170R01			IN 2505
21,8		TKA2180R01	TMA2180R01	TPA2180R01			IN 2505
21,9		TKA2190R01	TMA2190R01	TPA2190R01			IN 2505
22,0	TNA2200R01						IN 05S
22,0		TKA2200R01	TMA2200R01	TPA2200R01	TPF2200R01		IN 2505
22,1		TKA2210R01	TMA2210R01	TPA2210R01			IN 2505
22,2		TKA2220R01	TMA2220R01	TPA2220R01			IN 2505
22,3		TKA2230R01	TMA2230R01	TPA2230R01			IN 2505
22,4		TKA2240R01	TMA2240R01	TPA2240R01			IN 2505
22,5	TNA2250R01						IN 05S
22,5		TKA2250R01	TMA2250R01	TPA2250R01	TPF2250R01		IN 2505
22,6		TKA2260R01	TMA2260R01	TPA2260R01			IN 2505
22,7		TKA2270R01	TMA2270R01	TPA2270R01			IN 2505
22,8		TKA2280R01	TMA2280R01	TPA2280R01			IN 2505
22,9		TKA2290R01	TMA2290R01	TPA2290R01			IN 2505
23,0	TNA2300R01						IN 05S
23,0		TKA2300R01	TMA2300R01	TPA2300R01	TPF2300R01		IN 2505
23,1		TKA2310R01	TMA2310R01	TPA2310R01			IN 2505
23,2		TKA2320R01	TMA2320R01	TPA2320R01			IN 2505
23,3		TKA2330R01	TMA2330R01	TPA2330R01			IN 2505
23,4		TKA2340R01	TMA2340R01	TPA2340R01			IN 2505
23,5	TNA2350R01						IN 05S
23,5		TKA2350R01	TMA2350R01	TPA2350R01	TPF2350R01		IN 2505
23,6		TKA2360R01	TMA2360R01	TPA2360R01			IN 2505
23,7		TKA2370R01	TMA2370R01	TPA2370R01			IN 2505
23,8		TKA2380R01	TMA2380R01	TPA2380R01			IN 2505
23,9		TKA2390R01	TMA2390R01	TPA2390R01			IN 2505
24,0	TNA2400R01						IN 05S
24,0		TKA2400R01	TMA2400R01	TPA2400R01	TPF2400R01		IN 2505
24,1		TKA2410R01	TMA2410R01	TPA2410R01			IN 2505
24,2		TKA2420R01	TMA2420R01	TPA2420R01			IN 2505
24,3		TKA2430R01	TMA2430R01	TPA2430R01			IN 2505
24,4		TKA2440R01	TMA2440R01	TPA2440R01			IN 2505
24,5	TNA2450R01						IN 05S
24,5		TKA2450R01	TMA2450R01	TPA2450R01	TPF2450R01		IN 2505
24,6		TKA2460R01	TMA2460R01	TPA2460R01			IN 2505
24,7		TKA2470R01	TMA2470R01	TPA2470R01			IN 2505
24,8		TKA2480R01	TMA2480R01	TPA2480R01			IN 2505
24,9		TKA2490R01	TMA2490R01	TPA2490R01			IN 2505
25,0	TNA2500R01						IN 05S
25,0		TKA2500R01	TMA2500R01	TPA2500R01	TPF2500R01		IN 2505
25,1		TKA2510R01	TMA2510R01	TPA2510R01			IN 2505
25,2		TKA2520R01	TMA2520R01	TPA2520R01			IN 2505
25,3		TKA2530R01	TMA2530R01	TPA2530R01			IN 2505
25,4		TKA2540R01	TMA2540R01	TPA2540R01			IN 2505
25,5	TNA2550R01						IN 05S
25,5		TKA2550R01	TMA2550R01	TPA2550R01	TPF2550R01		IN 2505
25,6		TKA2560R01	TMA2560R01	TPA2560R01			IN 2505
25,7		TKA2570R01	TMA2570R01	TPA2570R01			IN 2505

AUFNAHME KOMPATIBEL MIT DIN 1835 B
 ADAPTION ACC. TO DIN 1835 B

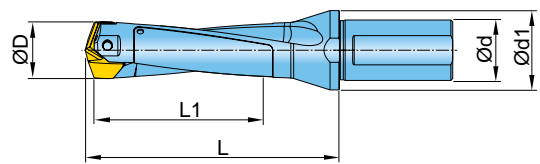

Artikel-Nr. Designation	D	D min.	D max.	d	d1	L	L1	Bs	kg
LD2600078JGR00	26	26,0	26,9	32	40	117,0	78	26	0,680
LD2700081JGR00	27	27,0	27,9	32	40	120,0	81	27	0,670
LD2800084JGR00	28	28,0	28,9	32	40	128,4	84	28	0,790
LD2900087JGR00	29	29,0	29,9	32	40	131,4	87	29	0,860
LD3000090JGR00	30	30,0	30,9	32	42	134,7	90	30	0,510
LD3100093JGR00	31	31,0	31,9	32	42	137,7	93	31	0,800
LD3200096JHR00	32	32,0	32,9	40	48	143,0	96	32	1,200
LD3300099JHR00	33	33,0	33,9	40	48	146,0	99	33	1,280
LD3400102JHR00	34	34,0	34,9	40	48	149,0	102	34	1,365
LD3500105JHR00	35	35,0	35,9	40	48	152,4	105	35	1,360
LD3600108JHR00	36	36,0	36,9	40	48	155,4	108	36	1,260
LD3700111JHR00	37	37,0	37,9	40	48	158,4	111	37	1,420
LD3800114JHR00	38	38,0	38,9	40	50	166,9	114	38	1,850
LD3900117JHR00	39	39,0	39,9	40	50	169,9	117	39	0,470
LD4000120JHR00	40	40,0	41,0	40	50	172,9	120	40	1,730

ZUBEHÖR
 SPARE PARTS



Durchmesserbereich / Diameter Range

26 - 27	TS 50230D3	DS-T20T
28 - 29	TS 50250D35	DS-T25T
30 - 31	TS 60265D4	DS-T25T
32 - 34	TS 60285D42	DS-T25T
35 - 37	TS 60320D5	DS-T25T
38 - 40	TS 80340D6	DS-T25T

① = Spannschraube / Insert screw ② = Schraubendreher / Screw driver

AUFNAHME KOMPATIBEL MIT DIN 1835 B
 ADAPTION ACC. TO DIN 1835 B

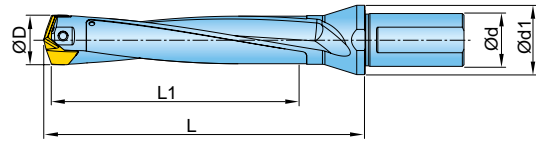

Artikel-Nr. Designation	D	D min.	D max.	d	d1	L	L1	Bs	
LD2600130JGR00	26	26,0	26,9	32	40	169,0	130	26	0,250
LD2700135JGR00	27	27,0	27,9	32	40	174,0	135	27	0,900
LD2800140JGR00	28	28,0	28,9	32	40	184,4	140	28	0,940
LD2900145JGR00	29	29,0	29,9	32	40	189,4	145	29	0,950
LD3000150JGR00	30	30,0	30,9	32	42	194,7	150	30	1,470
LD3100155JGR00	31	31,0	31,9	32	42	199,7	155	31	1,100
LD3200160JHR00	32	32,0	32,9	40	48	207,0	160	32	1,360
LD3300165JHR00	33	33,0	33,9	40	48	212,0	165	33	1,940
LD3400170JHR00	34	34,0	34,9	40	48	217,0	170	34	1,570
LD3500175JHR00	35	35,0	35,9	40	48	222,4	175	35	1,590
LD3600180JHR00	36	36,0	36,9	40	48	227,4	180	36	1,770
LD3700185JHR00	37	37,0	37,9	40	48	232,4	185	37	1,250
LD3800190JHR00	38	38,0	38,9	40	50	242,9	190	38	1,470
LD3900195JHR00	39	39,0	39,9	40	50	247,9	195	39	2,520
LD4000200JHR00	40	40,0	41,0	40	50	252,9	200	40	1,350

ZUBEHÖR
 SPARE PARTS

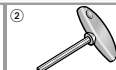

Durchmesserbereich / Diameter Range

26 - 27	TS 50230D3	DS-T20T
28 - 29	TS 50250D35	DS-T25T
30 - 31	TS 60265D4	DS-T25T
32 - 34	TS 60285D42	DS-T25T
35 - 37	TS 60320D5	DS-T25T
38 - 40	TS 80340D6	DS-T25T

① = Spannschraube / Insert screw ② = Schraubendreher / Screw driver

BOHRKÖPFE FÜR SPADETWIST
BORING HEADS FOR SPADETWIST

Stahl Bearbeitung

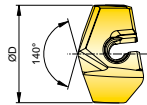

Artikel-Nr. / Designation			Artikel-Nr. / Designation		
D	Stahl / Steel	Qualität / Grade	D	Stahl / Steel	Qualität / Grade
26,0	LPA2600R01	IN 2505			
26,5	LPA2650R01	IN 2505			
27,0	LPA2700R01	IN 2505			
27,5	LPA2750R01	IN 2505			
28,0	LPA2800R01	IN 2505			
28,5	LPA2850R01	IN 2505			
29,0	LPA2900R01	IN 2505			
29,5	LPA2950R01	IN 2505			
30,0	LPA3000R01	IN 2505			
30,5	LPA3050R01	IN 2505			
31,0	LPA3100R01	IN 2505			
31,5	LPA3150R01	IN 2505			
32,0	LPA3200R01	IN 2505			
32,5	LPA3250R01	IN 2505			
33,0	LPA3300R01	IN 2505			
33,5	LPA3350R01	IN 2505			
34,0	LPA3400R01	IN 2505			
34,5	LPA3450R01	IN 2505			
35,0	LPA3500R01	IN 2505			
35,5	LPA3550R01	IN 2505			
36,0	LPA3600R01	IN 2505			
36,5	LPA3650R01	IN 2505			
37,0	LPA3700R01	IN 2505			
37,5	LPA3750R01	IN 2505			
38,0	LPA3800R01	IN 2505			
38,5	LPA3850R01	IN 2505			
39,0	LPA3900R01	IN 2505			
39,5	LPA3950R01	IN 2505			
40,0	LPA4000R01	IN 2505			
40,5	LPA4050R01	IN 2505			
41,0	LPA4100R01	IN 2505			

A large grid of small circles, intended for taking notes. The grid consists of 20 columns and 30 rows of circles, each circle being approximately 10x10 units in size. The circles are arranged in a uniform pattern across the page.

AUFNAHME KOMPATIBEL MIT DIN 1835 B
 ADAPTION ACC. TO DIN 1835 B

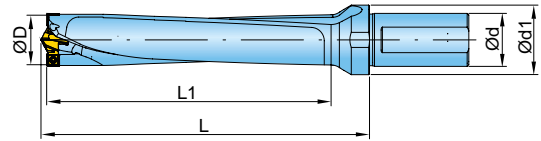

Artikel-Nr. Designation	D	d	d1	L	L1	Z	Zeff	Bs	Schlüssel / Wrench	IK	kg	Passende WSP Related Insert
CD2600130JGR00	26	32	40	167,7	130	2	2	TPA1590R01-C	KTD15.0-15.9-C	✓	0,70	A
CD2700135JGR00	27	32	40	173,8	135	2	2	TPA1690R01-C	KTD16.0-16.9-C	✓	0,76	A
CD2800140JGR00	28	32	40	179,9	140	2	2	TPA1790R01-C	KTD17.0-17.9-C	✓	0,80	A
CD2900145JGR00	29	32	40	184,2	145	2	2	TPA1590R01-C	KTD15.0-15.9-C	✓	0,87	B
CD3000150JGR00	30	32	40	190,3	150	2	2	TPA1690R01-C	KTD16.0-16.9-C	✓	0,99	B
CD3100155JGR00	31	32	40	196,4	155	2	2	TPA1790R01-C	KTD17.0-17.9-C	✓	1,08	B
CD3200160JGR00	32	32	40	202,5	160	2	2	TPA1890R01-C	KTD18.0-18.9-C	✓	1,15	B
CD3300165JHR00	33	40	50	210,2	165	2	2	TPA1590R01-C	KTD15.0-15.9-C	✓	1,28	C
CD3400170JHR00	34	40	50	216,3	170	2	2	TPA1690R01-C	KTD16.0-16.9-C	✓	1,36	C
CD3500175JHR00	35	40	50	222,4	175	2	2	TPA1790R01-C	KTD17.0-17.9-C	✓	1,49	C
CD3600180JHR00	36	40	50	228,5	180	2	2	TPA1890R01-C	KTD18.0-18.9-C	✓	1,56	C
CD3700185JHR00	37	40	50	232,8	185	2	2	TPA1690R01-C	KTD16.0-16.9-C	✓	1,68	D
CD3800190JHR00	38	40	50	238,9	190	2	2	TPA1790R01-C	KTD17.0-17.9-C	✓	1,77	D
CD3900195JHR00	39	40	50	245,0	195	2	2	TPA1890R01-C	KTD18.0-18.9-C	✓	1,89	D
CD4000200JHR00	40	40	50	251,0	200	2	2	TPA1990R01-C	KTD19.0-19.9-C	✓	1,96	D
CD4100205JHR00	41	40	50	257,1	205	2	2	TPA2090R01-C	KTD20.0-20.9-C	✓	2,09	D
CD4200210JHR00	42	40	50	263,1	210	2	2	TPA2190R01-C	KTD21.0-21.9-C	✓	2,17	D
CD4300215JHR00	43	40	50	269,2	215	2	2	TPA2290R01-C	KTD22.0-22.9-C	✓	2,29	D
CD4400220JHR00	44	40	50	275,3	220	2	2	TPA2390R01-C	KTD23.0-23.9-C	✓	2,37	D
CD4500225JHR00	45	40	50	281,2	225	2	2	TPA2490R01-C	KTD24.0-24.9-C	✓	2,46	D

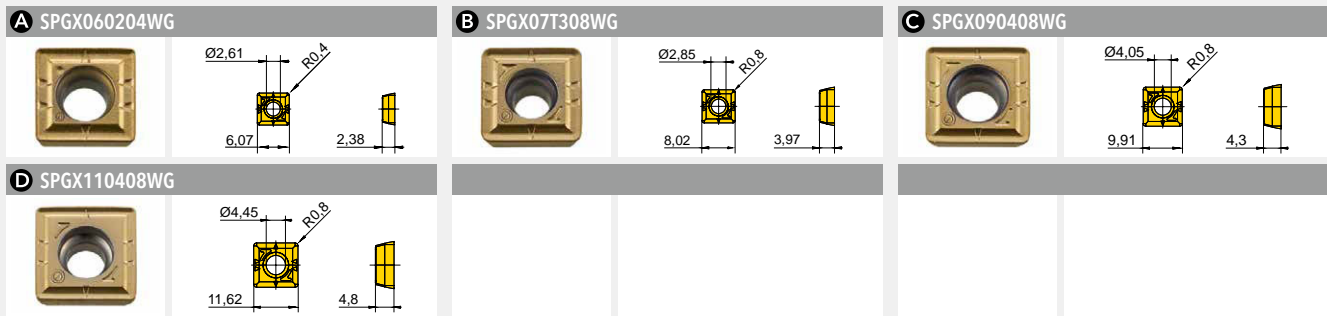

Artikel-Nr. Designation	fz(min/max)	Ausführung Design	Qualität Grade	IN2505						
SPGX060204WG	0,05/0,20	positive Geometrie R0,4 / positive geometry R0,4								
SPGX07T308WG	0,05/0,22	positive Geometrie R0,8 / positive geometry R0,8								
SPGX090408WG	0,07/0,24	positive Geometrie R0,8 / positive geometry R0,8								
SPGX110408WG	0,07/0,25	positive Geometrie R0,8 / positive geometry R0,8								

● = P ● = M ● = K ● = N ● = S ○ = H

ZUBEHÖR SPARE PARTS	
①	②
Durchmesserbereich / Diameter Range	
26 - 28	SM22-052-00 (0,8Nm) DS-T07S
29 - 32	SM25-064-00 (1,1Nm) DS-T08S
33 - 36	SM35-088-60 (3,0Nm) DS-T10S
37 - 45	SM40-093-20 (4,5Nm) DS-T15S

① = Spannschraube / Insert screw ② = Schraubendreher / Screw driver

BOHRKÖPFE FÜR GOLDTWIN
BORING HEADS FOR GOLDTWIN

Stahl Bearbeitung

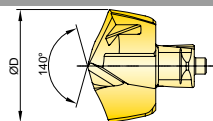

Artikel-Nr. / Designation			Artikel-Nr. / Designation		
D	Stahl / Steel	Qualität / Grade	D	Stahl / Steel	Qualität / Grade
15,9	TPA1590R01-C	IN 2505			
16,9	TPA1690R01-C	IN 2505			
17,9	TPA1790R01-C	IN 2505			
18,9	TPA1890R01-C	IN 2505			
19,9	TPA1990R01-C	IN 2505			
20,9	TPA2090R01-C	IN 2505			
21,9	TPA2190R01-C	IN 2505			
22,9	TPA2290R01-C	IN 2505			
23,9	TPA2390R01-C	IN 2505			
24,9	TPA2490R01-C	IN 2505			

A large grid of small circles, intended for taking notes. The grid consists of 20 columns and 30 rows of circles, totaling 600 circles. The circles are arranged in a uniform pattern across the page.

NEGATIVE 80° WENDESCHNEIDPLATTE UMFANGSGESCHLIFFEN, FÜR LEICHTE BIS MITTLERE BEARBEITUNG / SEHR SCHARF
NEGATIVE 80° RHOMBIC GROUND INSERTS, FOR MEDIUM TO LIGHT MACHINING / VERY SHARP

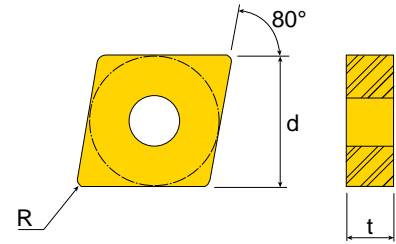

Artikel-Nr. Designation	f (min/max)	ap (min/max)	d	t	R	Qualität Grade	TT5080	K10
CNGG 090401 ML	0,05 (0,03/0,10)	0,2 (0,1/1,0)	9,52	4,76	0,1			
CNGG 090402 ML	0,07 (0,05/0,15)	0,3 (0,2/1,2)	9,52	4,76	0,2			
CNGG 090404 ML	0,18 (0,10/0,30)	1,2 (0,8/3,0)	9,52	4,76	0,4			
CNGG 090408 ML	0,25 (0,12/0,35)	1,5 (1,0/3,0)	9,52	4,76	0,8			

Für Halter / for tool holders: HC_NR/L 0904; TC_NR/L 0904; A_- HC_NR/L 0904; A_-TC_NR/L 0904 & A/S_-HC_NR/L 0904

● = P ● = M ● = K ● = N ● = S ○ = H

NEGATIVE 80° WENDESCHNEIDPLATTE UMFANGSGESCHLIFFEN, FÜR LEICHTE BIS MITTLERE BEARBEITUNG / SEHR SCHARF
NEGATIVE 80° RHOMBIC GROUND INSERTS, FOR MEDIUM TO LIGHT MACHINING / VERY SHARP

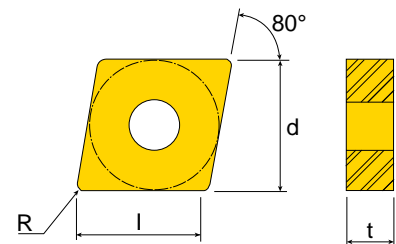
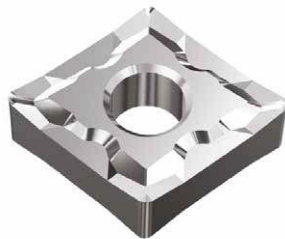

Artikel-Nr. Designation	f (min/max)	ap (min/max)	d	t	R	l	Qualität Grade	TT5080	K10
CNGG 120401 ML	0,05 (0,03/0,10)	0,2 (0,1/1,0)	12,70	4,76	0,1	12,8			
CNGG 120402 ML	0,07 (0,05/0,15)	0,3 (0,2/1,2)	12,70	4,76	0,2	12,7			
CNGG 120404 ML	0,18 (0,10/0,30)	1,5 (0,8/3,5)	12,70	4,76	0,4	12,4			
CNGG 120408 ML	0,25 (0,12/0,35)	2,0 (1,0/3,5)	12,70	4,76	0,8	12,0			

Für Halter/ for tool holders: TC_NL/R; PC_NL/R & C_-TCLNR/L

● = P ● = M ● = K ● = N ● = S ○ = H

NEGATIVE 80° WENDESCHNEIDPLATTE, FÜR LEICHTE BIS MITTLERE BEARBEITUNG / SEHR SCHARF
NEGATIVE 80° RHOMBIC INSERT, FOR MEDIUM TO LIGHT MACHINING / VERY SHARP

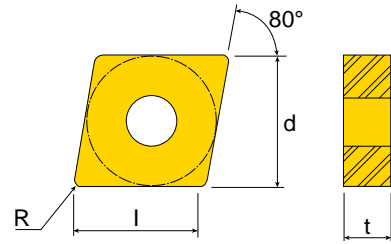

Artikel-Nr. Designation	f (min/max)	ap (min/max)	d	t	R	l								
CNMG 120404 ML	0,18 (0,10/0,30)	1,5 (0,8/3,5)	12,70	4,76	0,4	12,4								
CNMG 120408 ML	0,25 (0,12/0,35)	2,0 (1,0/3,5)	12,70	4,76	0,8	12,0								
CNMG 120412 ML	0,30 (0,15/0,35)	2,0 (1,3/3,5)	12,70	4,76	1,2	11,6								
Für Halter/ for tool holders: TC_NL/R; PC_NL/R & C_TCLNR/L														
Artikel-Nr. Designation	Qualität Grade	TT8115	TT9215	TT5080	TT8125	TT5100	TT9225	TT8080	TT8020	K10				
CNMG 120404 ML		●	●	●	●	●	●	●	●	●				
CNMG 120408 ML		●	●	●	●	●	●	●	●	●				
CNMG 120412 ML		●		●		●		●						

● = P ● = M ● = K ● = N ● = S ○ = H

NEGATIVE 80° WENDESCHNEIDPLATTE, FÜR MITTLERE BEARBEITUNG / POSITIVER SPANWINKEL
NEGATIVE 80° RHOMBIC INSERT, FOR MEDIUM MACHINING / POSITIVE RAKE ANGLE

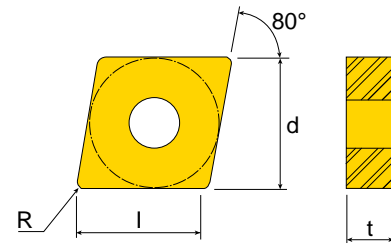

Artikel-Nr. Designation	f (min/max)	ap (min/max)	d	t	R	l
CNMG 120404 MP	0,21 (0,10/0,30)	2,0 (0,8/4,0)	12,70	4,76	0,4	12,4
CNMG 120408 MP	0,30 (0,12/0,40)	2,0 (1,0/4,0)	12,70	4,76	0,8	12,0
CNMG 120412 MP	0,36 (0,15/0,50)	2,0 (1,5/4,0)	12,70	4,76	1,2	11,6
CNMG 160612 MP	0,36 (0,15/0,50)	3,0 (2,5/6,0)	15,88	6,35	1,2	14,8

Für Halter/ for tool holders: TC_NL/R; PC_NL/R & C_TCLNR/L

Artikel-Nr. Designation	Qualität Grade	TT8115	TT9215	TT5080	TT8125	TT5100	TT9225	TT9080	TT7100	TT9235	TT8080	TT8020		
CNMG 120404 MP		●	●	●	●	●	●			●	●	●		
CNMG 120408 MP		●	●	●	●	●	●	●	●	●	●	●		
CNMG 120412 MP		●	●	●	●	●	●			●		●		
CNMG 160612 MP					●									

● = P ● = M ● = K ● = N ● = S ○ = H

NEGATIVE 55° WENDESCHNEIDPLATTE, ZUR MITTLEREN BEARBEITUNG / SEHR SCHARF / UMFANGSGESCHLIFFEN
NEGATIVE 55° RHOMBIC GROUND INSERTS, FOR MEDIUM LIGHT MACHINING / VERY SHARP

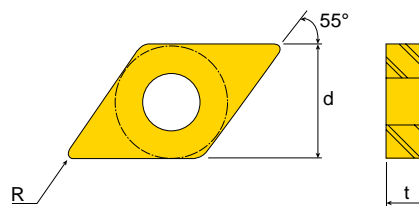

Artikel-Nr. Designation	f (min/max)	ap (min/max)	d	t	R	Qualität Grade	TT5080	K10
DNGG 130501 ML	0,05 (0,03/0,10)	0,2 (0,1/1,0)	11,11	5,56	0,1		●	●
DNGG 130502 ML	0,07 (0,05/0,15)	0,3 (0,2/1,2)	11,11	5,56	0,2		●	●
DNGG 130504 ML	0,18 (0,10/0,30)	1,2 (0,8/3,5)	11,11	5,56	0,4		●	●
DNGG 130508 ML	0,25 (0,12/0,35)	1,5 (1,0/3,5)	11,11	5,56	0,8		●	●

Für Halter / for tool holders TD_NR/L 1305; HD_NR/L 1305; A_-HD_NR/L 1305; A_-TD_NR/L 1305 & C_-HDJNR 1305

● = P ● = M ● = K ● = N ● = S ○ = H

NEGATIVE 55° WENDESCHNEIDPLATTE, ZUR MITTLEREN BEARBEITUNG / SEHR SCHARF / UMFANGSGESCHLIFFEN
NEGATIVE 55° RHOMBIC GROUND INSERTS, FOR MEDIUM MACHINING / VERY SHARP

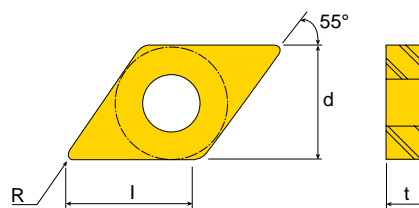
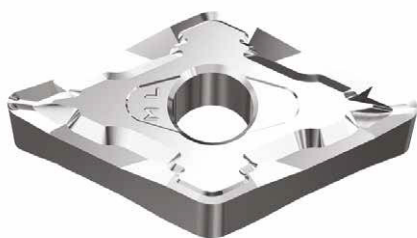

Artikel-Nr. Designation	f (min/max)	ap (min/max)	d	t	R	l	Qualität Grade	TT5080	K10
DNGG 150402 ML	0,18 (0,10/0,30)	1,2 (0,8/3,5)	12,70	4,76	0,2	14,7		●	
DNGG 150404 ML	0,18 (0,10/0,30)	1,2 (0,8/3,5)	12,70	4,76	0,4	15,1		●	●
DNGG 150408 ML	0,25 (0,12/0,35)	1,5 (1,0/3,5)	12,70	4,76	0,8	14,7		●	●

Für Halter/ for tool holders: TD_NL/R; PD_NL/R & A_-PD_NR/L

● = P ● = M ● = K ● = N ● = S ○ = H

NEGATIVE 55° WENDESCHNEIDPLATTE, FÜR LEICHTE BIS MITTLERE BEARBEITUNG / SEHR SCHARF
NEGATIVE 55° RHOMBIC INSERTS, FOR LIGHT TO MEDIUM MACHINING / VERY SHARP

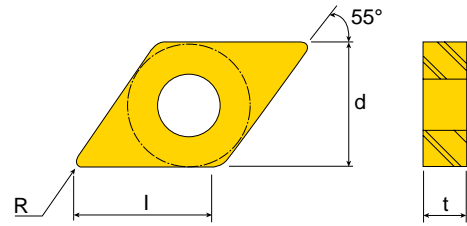

Artikel-Nr. Designation	f (min/max)	ap (min/max)	d	t	R	l	Qualität Grade	TT8115	TT5080	TT8125	TT5100	TT8080	TT8020	K10
DNMG 150604 ML	0,18 (0,10/0,30)	1,2 (0,8/3,5)	12,70	6,35	0,4	15,1		●	●	●	●	●		
DNMG 150608 ML	0,25 (0,12/0,35)	1,5 (1,0/3,5)	12,70	6,35	0,8	14,7		●	●	●	●	●	●	●

Für Halter/ for tool holders: TD_NL/R; PD_NL/R & A_PD_NR/L

● = P ● = M ● = K ● = N ● = S ○ = H

NEGATIVE 55° WENDESCHNEIDPLATTE, ZUR MITTLEREN BEARBEITUNG / POSITIVER SPANWINKEL
NEGATIVE 55° RHOMBIC INSERTS, FOR MEDIUM MACHINING/ POSITIVE RAKE ANGLE

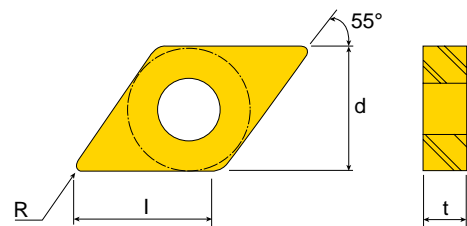

Artikel-Nr. Designation	f (min/max)	ap (min/max)	d	t	R	l	Qualität Grade	TT8115	TT9215	TT5080	TT8125	TT5100	TT9225	TT9235	TT8020
DNMG 150604 MP	0,21 (0,10/0,30)	1,5 (0,8/4,0)	12,70	6,35	0,4	15,1		●		●	●	●	●	●	
DNMG 150608 MP	0,30 (0,12/0,40)	2,0 (1,0/4,0)	12,70	6,35	0,8	14,7		●	●	●	●	●	●	●	●

Für Halter/ for tool holders: TD_NL/R; PD_NL/R & A_PD_NR/L

● = P ● = M ● = K ● = N ● = S ○ = H

NEGATIVE 90° WENDESCHEIDPLATTE, ZUR MITTLEREN BEARBEITUNG / POSITIVER SPANWINKEL
NEGATIVE 90° SQUARE INSERTS, FOR MEDIUM MACHINING / POSITIVE RAKE ANGLE

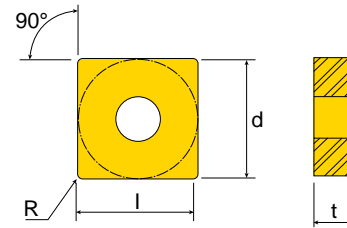

Artikel-Nr. Designation	f (min/max)	ap (min/max)	d	t	R	l										
SNMG 120404 MP	0,21 (0,10/0,30)	2,0 (0,8/4,0)	12,70	4,76	0,4	12,3										
SNMG 120408 MP	03,30 (0,12/0,40)	2,0 (1,0/4,0)	12,70	4,76	0,8	11,9										
SNMG 120412 MP	0,36 (0,15/0,40)	2,0 (1,3/4,0)	12,70	4,76	1,2	11,5										
Für Halter/ for tool holders: PSBNR/L, PSDNN, PSSNR/L, TSDNN & TSKNR/L																
Artikel-Nr. Designation	Qualität Grade	TT8115	TT9215	TT5080	TT8125	TT5100	TT9225	TT9080	TT9235	TT8020						
SNMG 120404 MP		●			●	●				●						
SNMG 120408 MP		●	●	●	●	●	●	●	●	●						
SNMG 120412 MP		●		●	●	●	●									

● = P ● = M ● = K ● = N ● = S ○ = H

NEGATIVE 60° WENDESCHEIDPLATTE, ZUR MITTLEREN BEARBEITUNG VON ROSTFREIEN UND HITZEBESTÄNDIGEN MATERIALIEN
NEGATIVE 60° TRIANGULAR INSERTS, FOR STAINLESS STEEL AND HEAT RESISTANT MATERIAL

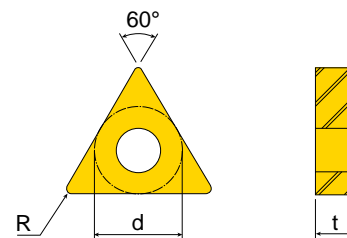

Artikel-Nr. Designation	f (min/max)	ap (min/max)	d	t	R	Qualität Grade	TT5080	TT9225	TT9080	TT9235
TNMG 130404 MK	0,20 (0,17/0,40)	1,8 (0,7/3,0)	7,94	4,76	0,4		●	●	●	●
TNMG 130408 MK	0,24 (0,20/0,45)	2,2 (1,0/3,5)	7,94	4,76	0,8		●	●	●	●
TNMG 130412 MK	0,28 (0,23/0,50)	2,6 (1,5/3,0)	7,94	4,76	1,2		●	●	●	●

Für Halter / for tool holders: HT_NR/L 1304; TT_NR/L 1304; A_-HT_NR/L 1304 & A_-TT_NR/L 1304

● = P ● = M ● = K ● = N ● = S ○ = H

NEGATIVE 60° WENDESCHNEIDPLATTE, FÜR LEICHTE BIS MITTLERE BEARBEITUNG / SEHR SCHARF
NEGATIVE 60° TRIANGULAR INSERTS, FOR LIGHT TO MEDIUM MACHINING / VERY SHARP

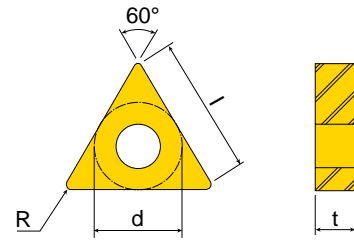

Artikel-Nr. Designation	f (min/max)	ap (min/max)	d	t	R	l	Qualität Grade	TT8115	TT5080	TT5100	TT8080	TT8020
TNMG 160404 ML	0,18 (0,10/0,30)	1,5 (0,8/3,5)	9,52	4,76	0,4	15,5	●	●	●	●	●	●
TNMG 160408 ML	0,25 (0,12/0,35)	1,5 (1,0/3,5)	9,52	4,76	0,8	14,5	●	●	●	●	●	●
TNMG 160412 ML	0,30 (0,15/0,35)	1,5 (1,5/3,5)	9,52	4,76	1,2	13,5	●					
TNMG 220404 ML	0,18 (0,10/0,30)	2,5 (1,0/4,0)	12,70	4,76	0,4	21,0	●		●			
TNMG 220408 ML	0,25 (0,12/0,35)	2,5 (1,0/4,0)	12,70	4,76	0,8	20,0	●		●			

Für Halter/ for tool holders: TTGNR/L & PTGNR/L

● = P ● = M ● = K ● = N ● = S ○ = H

NEGATIVE 35° WENDESCHNEIDPLATTE, ZUM MITTLEREN SCHRUPPEN
COMMON TYPE CHIPBREAKER, NEGATIVE 35° RHOMBIC INSERTS, FOR MEDIUM ROUGHING

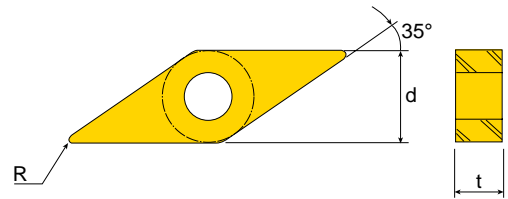

Artikel-Nr. Designation	f (min/max)	ap (min/max)	d	t	R	Qualität Grade	TT5080	K10
VNGG 160401 ML	0,05 (0,03/0,10)	0,5 (0,1/1,0)	9,52	4,76	0,1		●	
VNGG 160402 ML	0,08 (0,05/0,15)	0,6 (0,2/1,2)	9,52	4,76	0,2		●	●
VNGG 160404 ML	0,18 (0,10/0,27)	1,4 (0,8/3,0)	9,52	4,76	0,4		●	●
VNGG 160408 ML	0,21 (0,10/0,30)	1,6 (0,8/3,5)	9,52	4,76	0,8		●	●

Für Halter/ for tool holders: MVJNR/L; MVQNR/L; MVVNN; TVJNR/L; TVQNR/L & TVVNN

● = P ● = M ● = K ● = N ● = S ○ = H

NEGATIVE 80° TRIGON-WENDESCHNEIDPLATTE, ZUR MITTLEREN BEARBEITUNG / POSITIVER SPANWINKEL
CHIPBREAKER, NEGATIVE 80° TRIGON INSERTS, FOR MEDIUM MACHINING / POSITIVE RAKE ANGLE

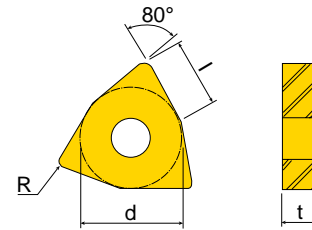

Artikel-Nr. Designation	f (min/max)	ap (min/max)	d	t	R	l
WNMG 060408 MP	0,30 (0,12/0,35)	1,5 (1,0/3,0)	9,52	4,76	0,8	6,1
WNMG 060412 MP	0,36 (0,15/0,40)	1,5 (1,3/3,0)	9,52	4,76	1,2	6,0
WNMG 080404 MP	0,25 (0,10/0,35)	2,0 (1,0/4,0)	12,70	4,76	0,4	8,4
WNMG 080408 MP	0,30 (0,12/0,40)	2,0 (1,0/4,0)	12,70	4,76	0,8	8,3
WNMG 080412 MP	0,36 (0,15/0,40)	2,0 (1,3/4,0)	12,70	4,76	1,2	8,2

Für Halter/ for tool holders: TWLNR/L; PwLNR/L & MWLNR/L

Artikel-Nr. Designation	Qualität Grade	TT8115	TT9215	TT5080	TT8125	TT5100	TT9225	TT9080	TT9235	TT8020				
WNMG 060408 MP		●		●	●	●	●	●	●	●				
WNMG 060412 MP		●				●								
WNMG 080404 MP					●									
WNMG 080408 MP		●	●	●	●	●	●	●	●	●				
WNMG 080412 MP		●	●	●	●	●	●		●					

● = P ● = M ● = K ● = N ● = S ○ = H

POSITIVE 80° WENDESCHNEIDPLATTE MIT 7° FREIWINKEL, FÜR ALUMINIUM MIT POLIERTER SPANFLÄCHE
CHIPBREAKER, POSITIVE 7° CLEARANCE 80° RHOMBIC INSERTS, FOR ALUMINUM MACHINING

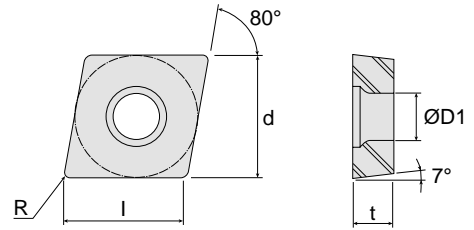

Artikel-Nr. Designation	d	t	R	ØD1	l	Qualität Grade	K10
CCGT 060202 FL	6,35	2,38	0,2	2,8	6,2		●
CCGT 060204 FL	6,35	2,38	0,4	2,8	6,0		●
CCGT 09T302 FL	9,53	3,97	0,2	4,4	9,4		●
CCGT 09T304 FL	9,53	3,97	0,4	4,4	9,2		●
CCGT 09T308 FL	9,53	3,97	0,8	4,4	8,8		●
CCGT 120402 FL	12,70	4,76	0,2	5,5	12,6		●
CCGT 120404 FL	12,70	4,76	0,4	5,5	12,4		●
CCGT 120408 FL	12,70	4,76	0,8	5,5	12,0		●

Für Halter/ for tool holders: BCLCR/L; SCLCR/L & SCACR/L

● = P ● = M ● = K ● = N ● = S ○ = H

POSITIVE 55° WENDESCHNEIDPLATTE MIT 7° FREIWINKEL, FÜR ALUMINIUM MIT POLIERTER SPANFLÄCHE
CHIPBREAKER, POSITIVE 7° CLEARANCE 55° RHOMBIC INSERTS, FOR ALUMINUM MACHINING

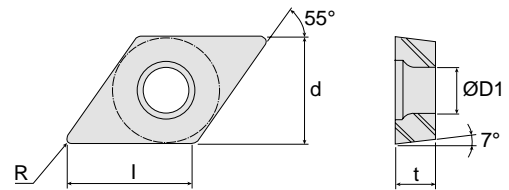

Artikel-Nr. Designation	d	t	R	ØD1	l	Qualität Grade	K10
DCGT 070202 FL	6,35	2,38	0,2	2,8	7,5		●
DCGT 070204 FL	6,35	2,38	0,4	2,8	7,3		●
DCGT 11T302 FL	9,53	3,97	0,2	4,4	11,4		●
DCGT 11T304 FL	9,53	3,97	0,4	4,4	11,2		●
DCGT 11T308 FL	9,53	3,97	0,8	4,4	10,8		●

Für Halter/ for tool holders: BDJ_; BDU_; SDJ_; SDN_; SDU_

● = P ● = M ● = K ● = N ● = S ○ = H

POSITIVE 55° WENDESCHNEIDPLATTE MIT 7° FREIWINKEL (UMFANGSGESCHLIFFEN), ZUR SCHLICHTBEARBEITUNG
POSITIVE 55° INSERT - 7° CLEARANCE (PERIPHERAL GROUND), FOR FINISHING

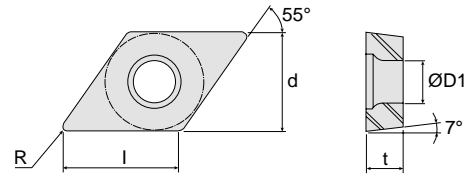

Artikel-Nr. Designation	f (min/max)	ap (min/max)	d	t	R	ØD1	l	Qualität Grade	PV3010	TT5080	TT9020
DCGT 070201 SA	0,08 (0,02/0,15)	0,8 (0,2/1,5)	6,35	2,38	0,1	2,8	7,6			●●●	●●●
DCGT 070202 SA	0,08 (0,02/0,15)	0,8 (0,1/1,5)	6,35	2,38	0,2	2,8	7,5			●●●	●●●
DCGT 070204 SA	0,11 (0,03/0,20)	0,8 (0,1/1,5)	6,35	2,38	0,4	2,8	7,3			●●●	●●●
DCGT 11T301 SA	0,03 (0,01/0,05)	1,3 (0,1/2,5)	9,53	3,97	0,1	4,4	11,5			●●●	●●●
DCGT 11T302 SA	0,09 (0,02/0,15)	1,3 (0,1/2,5)	9,53	3,97	0,2	4,4	11,4		●●●	●●●	●●●
DCGT 11T304 SA	0,11 (0,03/0,20)	1,3 (0,1/2,5)	9,53	3,97	0,4	4,4	11,2		●●●	●●●	●●●

Für Halter/ for tool holders: BD_CR/L & SD_CR/L

● = P ● = M ● = K ● = N ● = S ○ = H

POSITIVE 35° WENDESCHNEIDPLATTE MIT 5° FREIWINKEL (UMFANGSGESCHLIFFEN), ZUR SCHLICHTBEARBEITUNG
POSITIVE 35° INSERT - 5° CLEARANCE (PERIPHERAL GROUND), FOR FINISHING

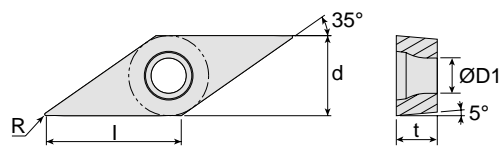

Artikel-Nr. Designation	f (min/max)	ap (min/max)	d	t	R	ØD1	l	Qualität Grade	TT5080	TT9020
VBGT 110301 SA	0,10 (0,01/0,20)	0,8 (0,1/1,5)	6,35	3,18	0,1	2,8	10,8		●●●	●●●
VBGT 110302 SA	0,11 (0,02/0,20)	0,8 (0,2/1,5)	6,35	3,18	0,2	2,8	10,6		●●●	●●●
VBGT 110304 SA	0,11 (0,03/0,20)	0,8 (0,1/1,5)	6,35	3,18	0,4	2,8	9,9		●●●	●●●
VBGT 160401 SA	0,10 (0,01/0,20)	0,8 (0,1/1,5)	9,52	4,76	0,1	4,4	15,6		●●●	●●●
VBGT 160402 SA	0,11 (0,02/0,20)	0,8 (0,2/1,5)	9,52	4,76	0,2	4,4	15,6		●●●	●●●
VBGT 160404 SA	0,11 (0,03/0,20)	0,8 (0,1/1,5)	9,52	4,76	0,4	4,4	15,6		●●●	●●●

Für Halter/ for tool holders: BVJBR/L-SH; SVJBR/L; SVQBR/L & SVVBN

● = P ● = M ● = K ● = N ● = S ○ = H

KLEMMHALTER MIT KNIEHEBELKLEMMUNG UND KÜHLMITTELEINHEIT, FÜR NEGATIVE 80° CN_ WENDESCHNEIDPLATTEN
EXTERNAL TOOL HOLDER WITH LEVER LOCK CLAMPING AND COOLANT, FOR NEGATIVE 80° CN_ INSERTS

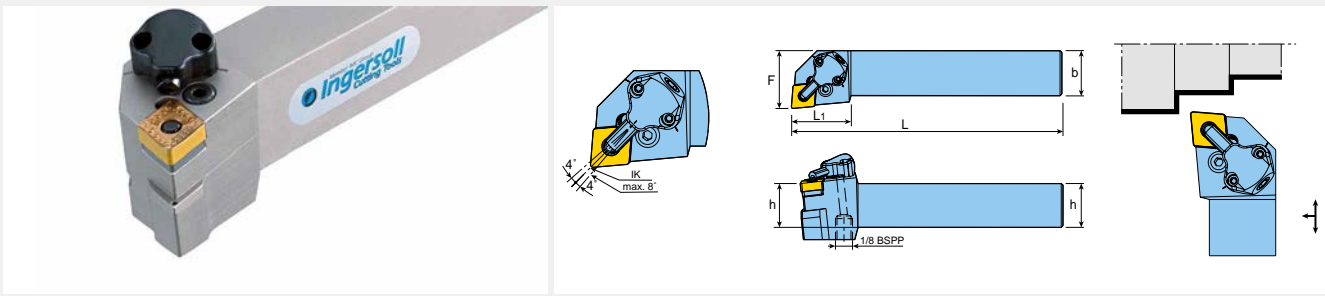

Artikel-Nr. Designation	L	L1	f	κ	h	b	Gew.	IK
----------------------------	---	----	---	---	---	---	------	----

PCLNL 2525 M12-TB	150	33	32	95°	25	25	0,830	✓
PCLNL 3232 P12-TB	170	33	40	95°	32	32	1,320	✓
PCLNR 2525 M12-TB	150	33	32	95°	25	25	0,770	✓
PCLNR 3232 P12-TB	170	33	40	95°	32	32	1,325	✓

Artikel-Nr. Designation		①	②	③	④	⑤	⑥	⑦	⑧
PCLNL 2525 M12-TB	CN_ 1204_	LCL 4	LCS 4	LSC 42	LSP 4	WS-0060	CU-CW-TB	ID 6.4x0.9	SS 4x0.7x4-NL
PCLNL 3232 P12-TB	CN_ 1204_	LCL 4	LCS 4	LSC 42	LSP 4	WS-0060	CU-CW-TB	ID 6.4x0.9	SS 4x0.7x4-NL
PCLNR 2525 M12-TB	CN_ 1204_	LCL 4	LCS 4	LSC 42	LSP 4	WS-0060	CU-CW-TB	ID 6.4x0.9	SS 4x0.7x4-NL
PCLNR 3232 P12-TB	CN_ 1204_	LCL 4	LCS 4	LSC 42	LSP 4	WS-0060	CU-CW-TB	ID 6.4x0.9	SS 4x0.7x4-NL

- ① = Kniehebel / Lever ② = Spannschraube / Clamp screw ③ = Unterlegplatte / Shim ④ = Kerbstift / Shim pin ⑤ = Schraubendreher / Wrench
⑥ = Kühlmittleinheit / Coolant unit ⑦ = O-Ring / O-Ring ⑧ = Stopfen / Plug

KLEMMHALTER MIT KNIEHEBELKLEMMUNG UND KÜHLMITTELEINHEIT, FÜR NEGATIVE 55° DN_ WENDESCHNEIDPLATTEN
EXTERNAL TOOL HOLDER WITH LEVER LOCK CLAMPING AND COOLANT, FOR NEGATIVE 55° DN_ INSERTS

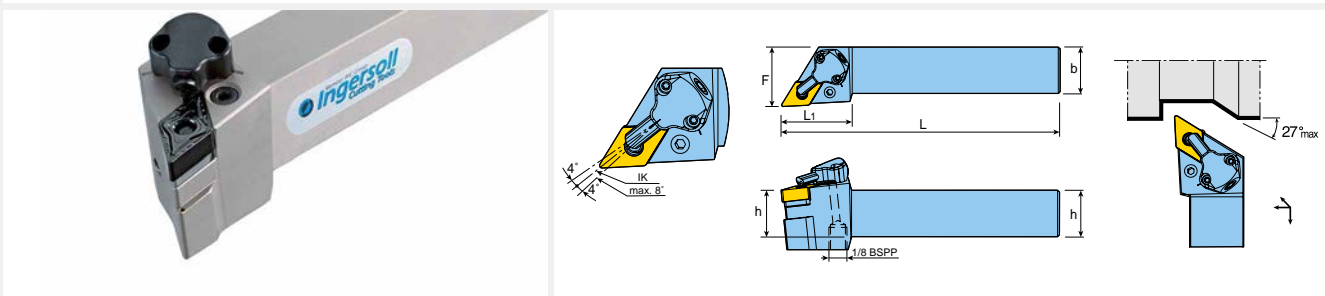

Artikel-Nr. Designation	L	L1	f	κ	h	b	Gew.	IK
----------------------------	---	----	---	---	---	---	------	----

PDJNL 2525 M1504-TB	150	37	32	93°	25	25	0,745	✓
PDJNL 2525 M1506-TB	150	37	32	93°	25	25	0,745	✓
PDJNR 2525 M1504-TB	150	37	32	93°	25	25	0,745	✓
PDJNR 2525 M1506-TB	150	37	32	93°	25	25	0,745	✓

Artikel-Nr. Designation		①	②	③	④	⑤	⑥	⑦	⑧
PDJNL 2525 M1504-TB	DN_ 1506_	LCL 4A	LCS 4	LSD 42	LSP 4	WS-0060	CU-D-TB	ID 6.4x0.9	SS 4x0.7x4-NL
PDJNL 2525 M1506-TB	DN_ 1506_	LCL 4A	LCS 4	LSD 43	LSP 4	WS-0060	CU-D-TB	ID 6.4x0.9	SS 4x0.7x4-NL
PDJNR 2525 M1504-TB	DN_ 1506_	LCL 4A	LCS 4	LSD 42	LSP 4	WS-0060	CU-D-TB	ID 6.4x0.9	SS 4x0.7x4-NL
PDJNR 2525 M1506-TB	DN_ 1506_	LCL 4A	LCS 4	LSD 43	LSP 4	WS-0060	CU-D-TB	ID 6.4x0.9	SS 4x0.7x4-NL

- ① = Kniehebel / Lever ② = Spannschraube / Clamp screw ③ = Unterlegplatte / Shim ④ = Kerbstift / Shim pin ⑤ = Schraubendreher / Wrench
⑥ = Kühlmittleinheit / Coolant unit ⑦ = O-Ring / O-Ring ⑧ = Stopfen / Plug

KLEMMHALTER MIT KNIEHEBELKLEMMUNG UND KÜHLMITTELEINHEIT, FÜR NEGATIVE 80° TRIGON WN_ WENDESCHNEIDPLATTEN
EXTERNAL TOOL HOLDER WITH LEVER LOCK CLAMPING AND COOLANT, FOR NEGATIVE 80° TRIGON WN_ INSERTS

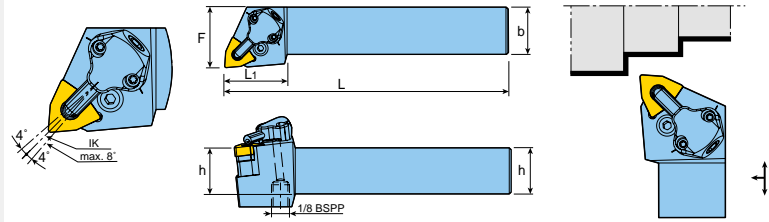

Artikel-Nr. Designation	L	L1	f	κ	h	b	Gew.	IK
PWLNL 2525 M08-TB	150	33	32	95°	25	25	0,780	✓
PWLNL 3232 P08-TB	170	33	40	95°	32	32	1,340	✓
PWLNR 2525 M08-TB	150	33	32	95°	25	25	0,780	✓
PWLNR 3232 P08-TB	170	33	40	95°	32	32	1,340	✓

Artikel-Nr. Designation									
PWLNL 2525 M08-TB	WN_0804_	LCL 4	LCS 4	TWN 423(T)	LSP 4	WS-0060	CU-CW-TB	ID 6.4x0.9	SS 4x0.7x4-NL
PWLNL 3232 P08-TB	WN_0804_	LCL 4	LCS 4	TWN 423(T)	LSP 4	WS-0060	CU-CW-TB	ID 6.4x0.9	SS 4x0.7x4-NL
PWLNR 2525 M08-TB	WN_0804_	LCL 4	LCS 4	TWN 423(T)	LSP 4	WS-0060	CU-CW-TB	ID 6.4x0.9	SS 4x0.7x4-NL
PWLNR 3232 P08-TB	WN_0804_	LCL 4	LCS 4	TWN 423(T)	LSP 4	WS-0060	CU-CW-TB	ID 6.4x0.9	SS 4x0.7x4-NL

① = Kniehebel / Lever ② = Spanschraube / Clamp screw ③ = Unterlegplatte / Shim ④ = Kerbstift / Shim pin
⑤ = Schraubendreher / Wrench ⑥ = Kühlmittleinheit / Coolant unit ⑦ = O-Ring / O-Ring ⑧ = Stopfen / Plug

KLEMMHALTER MIT SCHRAUBENKLEMMUNG UND KÜHLMITTELEINHEIT, FÜR POSITIVE RC_ RUND-WENDESCHNEIDPLATTEN MIT 7° FREIWINKEL
EXTERNAL TOOL HOLDER WITH SCREW CLAMPING AND COOLANT, FOR POSITIVE RC_ ROUND INSERTS - 7° CLEARANCE

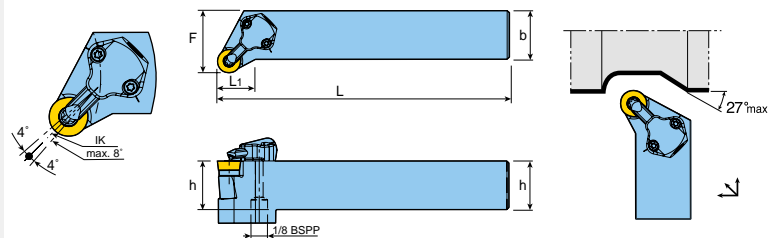

Artikel-Nr. Designation	L	L1	f	κ	h	b	Gew.	IK
SRGCL 2525 M12-TB	150	19,6	32	90°	25	25	0,745	✓
SRGCR 2525 M12-TB	150	19,6	32	90°	25	25	0,750	✓

Artikel-Nr. Designation								
SRGCL 2525 M12-TB	RC_I_1204_	TS 35110I	SSR 32	TS 5035062S	T 15	CU-R-TB	ID 6.4x0.9	SS 4x0.7x4-NL
SRGCR 2525 M12-TB	RC_I_1204_	TS 35110I	SSR 32	TS 5035062S	T 15	CU-R-TB	ID 6.4x0.9	SS 4x0.7x4-NL

① = Spanschraube / Clamp screw ② = Unterlegplatte / Shim ③ = Spanschraube / Clamp screw ④ = Schlüssel / Wrench
⑤ = Kühlmittleinheit / Coolant unit ⑥ = O-Ring / O-Ring ⑦ = Stopfen / Plug

KLEMMHALTER MIT SCHRAUBENKLEMMUNG UND KÜHLMITTELEINHEIT, FÜR POSITIVE 35° VB_ WENDESCHNEIDPLATTEN MIT 5° FREIWINKEL
EXTERNAL TOOL HOLDER WITH SCREW CLAMPING AND COOLANT, FOR POSITIVE 35° VB_ INSERTS - 5° CLEARANCE

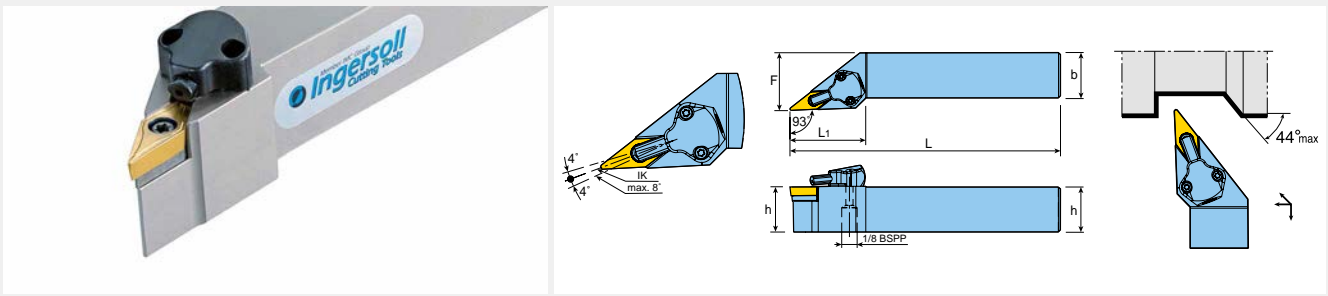

Artikel-Nr. Designation	L	L1	t	κ	h	b	Gew.	IK
SVJBL 2525 M16-TB	150	37	32	93°	25	25	0,660	✓
SVJBR 2525 M16-TB	150	37	32	93°	25	25	0,660	✓

Artikel-Nr. Designation							
SVJBL 2525 M16-TB	VB_1604_	SO 35124I	SSV 32	TS 5035062S	T 15	CU-V-TB	ID 6.4x0.9
SVJBR 2525 M16-TB	VB_1604_	SO 35124I	SSV 32	TS 5035062S	T 15	CU-V-TB	ID 6.4x0.9

- ① = Spannschraube / Clamp screw ② = Unterlegplatte / Shim ③ = Spannschraube / Clamp screw ④ = Schlüssel / Wrench
⑤ = Kühlmittleinheit / Coolant unit ⑥ = O-Ring / O-Ring

COMBI CLAMP™ TRGNR/L-F
TRGNR/L-F

KOMBIKLEMMHALTER, FÜR NEGATIVE RUNDKERAMIK-WENDESCHNEIDPLATTEN
COMBI CLAMP, T-HOLDER FOR ROUND CERAMIC INSERTS

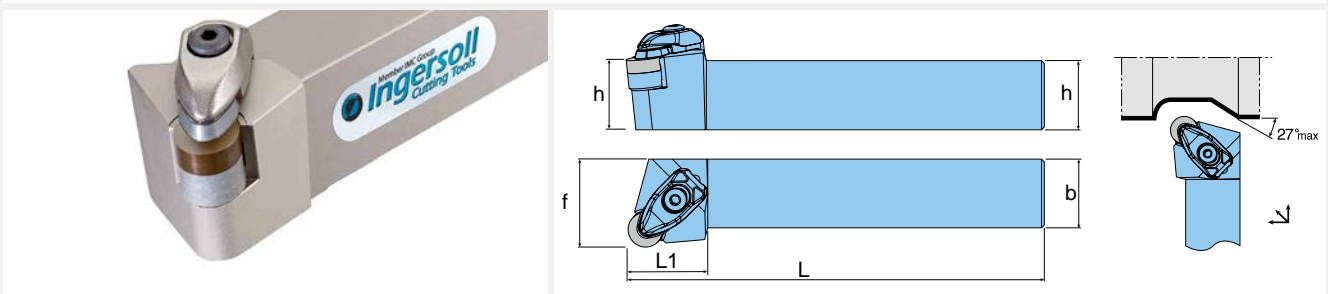

Artikel-Nr. Designation	L	L1	f	κ	h	b	Gew.							
TRGNL 2020 K1204-F	125	29	25	90°	20	20	0,410	RN_N_1204_	DCLS-4F	DLS 4	S 43-T8	BH M5X0.8X10	DSP 4	WS-0060
TRGNL 2525 M1204-F	150	29	32	90°	25	25	0,750	RN_N_1204_	DCLS-4F	DLS 4	S 43-T8	BH M5X0.8X10	DSP 4	WS-0060
TRGNL 2525 M1207-F	150	29	32	90°	25	25	0,745	RN_N_1207_	DCLS-4F	DLS 4	S 43	BH M5X0.8X8	DSP 4	WS-0060
TRGNL 3225 P1207-F	170	29	32	90°	32	25	1,065	RN_N_1207_	DCLS-4F	DLS 4	S 43	BH M5X0.8X8	DSP 4	WS-0060
TRGNR 2020 K1204-F	125	29	25	90°	20	20	0,410	RN_N_1204_	DCLS-4F	DLS 4	S 43-T8	BH M5X0.8X10	DSP 4	WS-0060
TRGNR 2020 K1207-F	125	29	25	90°	20	20	0,405	RN_N_1207_	DCLS-4F	DLS 4	S 43	BH M5X0.8X8	DSP 4	WS-0060
TRGNR 2525 M1204-F	150	29	32	90°	25	25	0,745	RN_N_1204_	DCLS-4F	DLS 4	S 43-T8	BH M5X0.8X10	DSP 4	WS-0060
TRGNR 2525 M1207-F	150	29	32	90°	25	25	0,740	RN_N_1207_	DCLS-4F	DLS 4	S 43	BH M5X0.8X8	DSP 4	WS-0060
TRGNR 3225 P1207-F	170	29	32	90°	32	25	1,065	RN_N_1207_	DCLS-4F	DLS 4	S 43	BH M5X0.8X8	DSP 4	WS-0060

- ① = Pratte / Clamp ② = Spannschraube / Clamp screw ③ = Unterlegplatte / Shim ④ = Spannschraube / Clamp screw
⑤ = Feder / Spring ⑥ = Schraubendreher / Wrench

BOHRSTANGE MIT SCHRAUBENKLEMMUNG UND INNENKÜHLUNG, FÜR NEGATIVE 80° CN_0904_ WENDESCHNEIDPLATTEN
SCREW CLAMPING TYPE BORING BAR WITH INTERNAL COOLANT, FOR NEGATIVE 80° CN_0904_ INSERTS

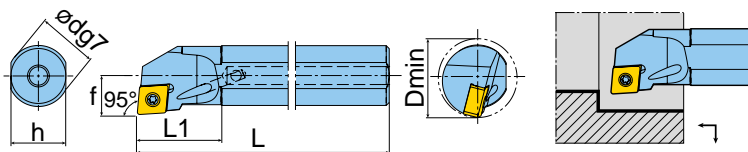

Artikel-Nr. Designation	D min.	d	L	L1	f	κ	h	Gew.	IK				
A16Q SCLNR 0904	20	16	180	25	11	95°	15	0,245	✓	CN_0904_	TS 350831/HG	T 10	RSS M4
A20Q SCLNR 0904	25	20	180	28	13	95°	18	0,375	✓	CN_0904_	TS 350831/HG	T 10	RSS M4
A16Q SCLNR 0904	20	16	180	25	11	95°	15	0,245	✓	CN_0904_	TS 350831/HG	T 10	RSS M4
A20Q SCLNR 0904	25	20	180	28	13	95°	18	0,375	✓	CN_0904_	TS 350831/HG	T 10	RSS M4

① = Spannschraube / Clamp screw ② = Schlüssel / Wrench ③ = Dichtschraube / Sealing screw

BOHRSTANGE MIT KNIEHEBEL UND INNENKÜHLUNG, FÜR NEGATIVE 55° DN_1305_ WENDESCHNEIDPLATTEN
INTERNAL TOOL HOLDER WITH LEVER LOCK CLAMPING AND INTERNAL COOLANT, FOR NEGATIVE 55° DN_1305_ INSERTS

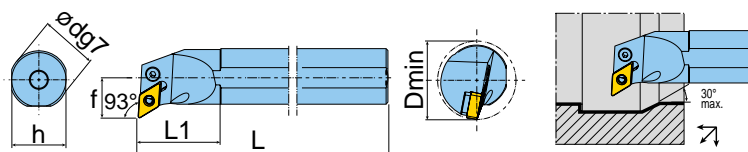

Artikel-Nr. Designation	D min.	d	L	L1	f	κ	h	Gew.	IK
A32S HDUNL 1305	40	32	250	45	22	93°	30	1,355	✓
A40T HDUNL 1305	50	40	300	55	27	93°	37	2,600	✓
A32S HDUNR 1305	40	32	250	45	22	93°	30	1,385	✓
A40T HDUNR 1305	50	40	300	55	27	93°	37	2,600	✓

Artikel-Nr. Designation						
A32S HDUNL 1305	DN_1305_	LCL 11-NX	LCS 4S	LSD 3.52B	LSP 4	WS-0060
A40T HDUNL 1305	DN_1305_	LCL 11-NX	LCS 4S	LSD 3.52B	LSP 4	WS-0060
A32S HDUNR 1305	DN_1305_	LCL 11-NX	LCS 4S	LSD 3.52B	LSP 4	WS-0060
A40T HDUNR 1305	DN_1305_	LCL 11-NX	LCS 4S	LSD 3.52B	LSP 4	WS-0060

① = Kniehebel / Lever ② = Spannschraube / Clamp screw ③ = Unterlegplatte / Shim ④ = Kerbstift / Shim pin ⑤ = Schraubendreher / Wrench

ZWEISEITIGE SCHNEIDEINSÄTZE ZUM AB- UND EINSTECHEN, MIT "J"-TYP SPANFORMER
DOUBLE ENDED INSERTS, WITH "J" TYPE CHIPBREAKER FOR PARTING AND GROOVING

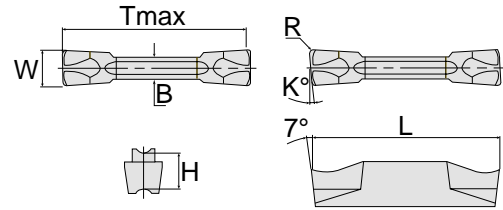
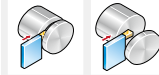

Artikel-Nr. Designation	R	B	H	K	I	T _{max}	W ± 0,05	WSP-S	Qualität Grade	TT9080	TT7220	TT8020	K10
TDJ 1,4	0,16	1,0	4,0	-	16	15	1,4	1					
TDJ 2	0,20	1,7	4,7	-	20,0	19	2,0	2					
TDJ 3	0,20	2,4	4,7	-	20,0	19	3,0	3					
TDJ 4	0,30	3,0	4,7	-	20,0	19	4,0	4					
TDJ 5	0,30	4,0	5,2	-	25,0	24	5,0	5					
TDJ 6	0,30	5,0	5,2	-	25,0	24	6,0	6					
TDJ 2-6L	0,20	1,7	4,7	6	20,0	19	2,0	2					
TDJ 2-6LS¹⁾	0,02	1,7	4,7	6	19,6	19	2,0	2					
TDJ 2-8L	0,20	1,7	4,7	8	20,0	19	2,0	2					
TDJ 2-15L	0,20	1,7	4,7	15	20,0	19	2,0	2					
TDJ 2-15LS¹⁾	0,02	1,7	4,7	15	19,6	19	2,0	2					
TDJ 3-6L	0,20	2,4	4,7	6	20,0	19	3,0	3					
TDJ 3-6LS¹⁾	0,02	2,4	4,7	6	19,6	19	3,0	3					
TDJ 3-15L	0,20	2,4	4,7	15	20,0	19	3,0	3					
TDJ 3-15LS¹⁾	0,02	2,4	4,7	15	19,6	19	3,0	3					
TDJ 4-4L	0,30	3,0	4,7	4	20,0	19	4,0	4					
TDJ 4-15L	0,30	3,0	4,7	15	20,0	19	4,0	4					
TDJ 5-4L	0,30	4,0	5,2	4	25,0	24	5,0	5					
TDJ 1,4-15RS	0,02	1,0	4,0	-	15,8	15	1,4	1					
TDJ 2-6R	0,20	1,7	4,7	6	20,0	19	2,0	2					
TDJ 2-6RS¹⁾	0,02	1,7	4,7	6	19,6	19	2,0	2					
TDJ 2-8R	0,20	1,7	4,7	8	20,0	19	2,0	2					
TDJ 2-15R	0,20	1,7	4,7	15	20,0	19	2,0	2					
TDJ 2-15RS¹⁾	0,02	1,7	4,7	15	19,6	19	2,0	2					
TDJ 3-6R	0,20	2,4	4,7	6	20,0	19	3,0	3					
TDJ 3-15R	0,20	2,4	4,7	15	20,0	19	3,0	3					
TDJ 3-15RS¹⁾	0,02	2,4	4,7	15	19,6	19	3,0	3					
TDJ 4-4R	0,30	3,0	4,7	4	20,0	19	4,0	4					
TDJ 4-15R	0,30	3,0	4,7	15	20,0	19	4,0	4					
TDJ 5-4R	0,30	4,0	5,2	4	25,0	24	5,0	5					

¹⁾ scharfer Eckenradius / sharp corner radius

● = P ● = M ● = K ● = N ● = S ○ = H

ZWEISEITIGE SCHNEIDEINSÄTZE ZUM AB- UND EINSTECHEN, MIT "C"-TYP SPANFORMER
DOUBLE ENDED INSERTS, WITH "C" TYPE CHIPBREAKER FOR PARTING AND GROOVING

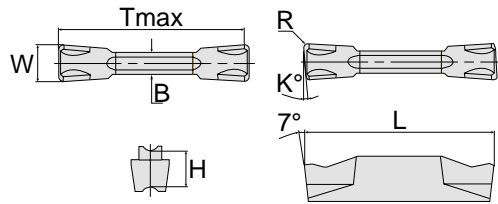
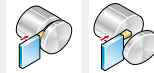

Artikel-Nr. Designation	R	B	H	K	l	Tmax	W ± 0,05	WSP-S	Qualität Grade	CT3000	TT5100	TT9080	TT7220	TT8020	K10
TDC 2	0,20	1,7	4,7	-	20,0	19	2,0	2		●●●		●●●	●●●	●●●	●●●
TDC 3	0,20	2,4	4,7	-	20,0	19	3,0	3			●●	●●●	●●●	●●●	●●●
TDC 4	0,30	3,0	4,7	-	20,0	19	4,0	4				●●●	●●●	●●●	●●●
TDC 5	0,30	4,0	5,2	-	25,0	24	5,0	5				●●●	●●●	●●●	●●●
TDC 6	0,30	5,0	5,2	-	25,0	24	6,0	6		●●●		●●●	●●●	●●●	●●●
TDC 8	0,40	6,0	6,4	-	30,0	29	8,0	8				●●		●●	
TDC 2-6L	0,20	1,7	4,7	6	20,0	19	2,0	2					●●	●●	
TDC 2-8L	0,20	1,7	4,7	8	20,0	19	2,0	2					●●		
TDC 2-15L	0,20	1,7	4,7	15	20,0	19	2,0	2					●●	●●	
TDC 2-15LS ¹⁾	0,02	1,7	4,7	15	19,6	19	2,0	2					●●	●●	
TDC 3-6L	0,20	2,4	4,7	6	20,0	19	3,0	3				●●	●●	●●	
TDC 3-6LS ¹⁾	0,02	2,4	4,7	6	19,6	19	3,0	3				●●	●●		
TDC 3-15L	0,20	2,4	4,7	15	20,0	19	3,0	3				●●	●●	●●	
TDC 4-4L	0,30	3,0	4,7	4	20,0	19	4,0	4				●●	●●	●●	
TDC 4-15L	0,30	3,0	4,7	15	20,0	19	4,0	4				●●		●●	
TDC 2-6R	0,20	1,7	4,7	6	20,0	19	2,0	2				●●	●●	●●	
TDC 2-6RS	0,02	1,7	4,7	6	19,8	19	2,0	2				●●			
TDC 2-8R	0,20	1,7	4,7	8	20,0	19	2,0	2					●●	●●	
TDC 2-15R	0,20	1,7	4,7	15	20,0	19	2,0	2				●●	●●	●●	
TDC 2-15RS ¹⁾	0,02	1,7	4,7	15	19,6	19	2,0	2				●●	●●	●●	
TDC 3-6R	0,20	2,4	4,7	6	20,0	19	3,0	3				●●	●●	●●	
TDC 3-6RS ¹⁾	0,02	2,4	4,7	6	19,6	19	3,0	3				●●	●●		
TDC 3-15R	0,20	2,4	4,7	15	20,0	19	3,0	3				●●	●●	●●	
TDC 4-4R	0,30	3,0	4,7	4	20,0	19	4,0	4				●●	●●	●●	
TDC 4-15R	0,30	3,0	4,7	15	20,0	19	4,0	4						●●	
TDC 5-4R	0,30	4,0	5,2	4	20,0	24	5,0	5				●●	●●		

¹⁾ scharfer Eckenradius / sharp corner radius

● = P ● = M ● = K ● = N ● = S ○ = H

4-SCHNEIDIGE STECHWENDESCHNEIDPLATTE, ZUM PREZISIONSEINSTECHEN MIT POSITIVEN SPANWINKEL
4-CUTTING EDGE INSERT, FOR PRECISION GROOVING, STRAIGHT CUTTING EDGES WITH HIGH POSITIVE RAKE ANGLE

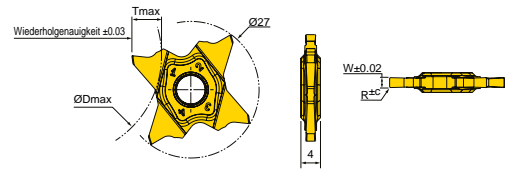

Artikel-Nr. Designation	R	T _{max}	W ± 0,02	Qualität Grade	CT3000	TT9080
TQS 27-1.00-0.10	0,10	3,5	1,00			
TQS 27-1.50-0.20	0,20	5,7	1,50			
TQS 27-2.00-0.20	0,20	6,4	2,00			
TQS 27-2.39-0.15	0,15	5,7	2,39			
TQS 27-2.50-0.20	0,20	5,7	2,50			
TQS 27-3.00-0.20	0,20	6,4	3,00			

Für Halter/ for tool holders: TQHR/L; TQHPR/L & TQCR/L/

● = P ● = M ● = K ● = N ● = S ○ = H

4-SCHNEIDIGE STECHWENDESCHNEIDPLATTE
4-CUTTING EDGE INSERT, FOR PRECISION GROOVING, PARTING AND RECESSING

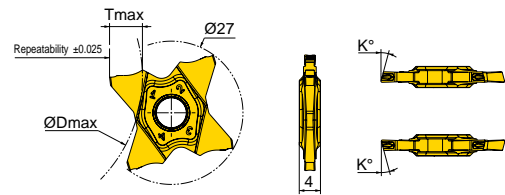
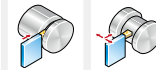

Artikel-Nr. Designation	R	K	T _{max}	W ± 0,02	Qualität Grade	TT9080
TQJ 27-1.00-15L	0,06	15	3,5	1,00		
TQJ 27-1.50-6L	0,06	6	5,0	1,50		
TQJ 27-1.50-15L	0,06	15	5,0	1,50		
TQJ 27-2.00-6L	0,10	6	6,4	2,00		
TQJ 27-2.00-15L	0,10	15	6,4	2,00		
TQJ 27-1.00-15R	0,06	15	3,5	1,00		
TQJ 27-1.50-6R	0,06	6	5,0	1,50		
TQJ 27-1.50-15R	0,06	15	5,0	1,50		
TQJ 27-2.00-6R	0,10	6	6,4	2,00		
TQJ 27-2.00-15R	0,10	15	6,4	2,00		

Für Halter/ for tool holders: TQHR/L; TQHPR/L & TQCR/L

● = P ● = M ● = K ● = N ● = S ○ = H

4-SCHNEIDIGE STECHWENDESCHNEIDPLATTE FÜR SICHERUNGSRINGE
4-CUTTING EDGE INSERT, FOR CIRCLIP AND SHALLOW GROOVING

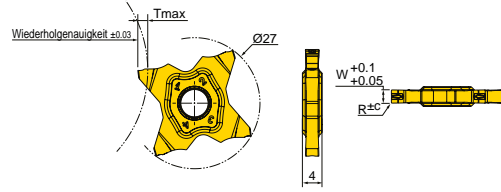
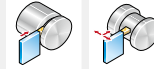

Artikel-Nr. Designation	R	Tmax	W ± 0,1	Qualität Grade	TT9080
TQJ 27-1.10-0.08-CG	0,08	1,50	1,10		
TQJ 27-1.30-0.08-CG	0,08	1,50	1,30		
TQJ 27-1.60-0.08-CG	0,08	2,00	1,60		
TQJ 27-1.85-0.08-CG	0,08	2,00	1,85		
TQJ 27-2.15-0.08-CG	0,08	2,5	2,15		
TQJ 27-2.65-0.15-CG	0,15	2,5	2,65		

Für Halter/ for tool holders: TQHR/L; TQHPR/L & TQCR/L

● = P ● = M ● = K ● = N ● = S ○ = H

KLEMMHALTER FÜR 4-SCHNEIDIGE STECHWENDESCHNEIDPLATTE FÜR HOCHDRUCK
HIGH PRESSURE TOOL FOR 4-CUTTING EDGES INSERTS

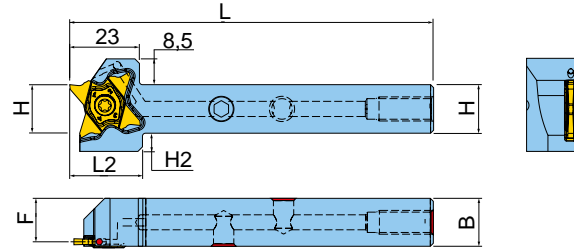
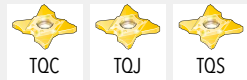



Artikel-Nr. Designation	L	L2	H	H2	B	F	Gew.	IK	①	②	③	④
TQHL 12-27-TB	120	24	12	8	12	10,5	0,320	✓	TS 50125I	T 10/20	PT 5/16 UNF	L-W 4
TQHL 16-27-TB	120	24	16	6	16	14,5	0,220	✓	TS 50125I	T 10/20	PT 5/16 UNF	L-W 4
TQHL 20-27-TB	120	24	20	2	20	18,5	0,370	✓	TS 50125I	T 10/20	PT 0.125X8-L5.5	L-W 5
TQHL 25-27-TB	135	-	25	-	25	23,5	0,600	✓	TS 50125I	T 10/20	PT 0.125X8-L5.5	L-W 5
TQHR 12-27-TB	120	24	12	8	12	10,5	0,130	✓	TS 50125IL	T 10/20	PT 5/16 UNF	L-W 4
TQHR 16-27-TB	120	24	16	6	16	14,5	0,270	✓	TS 50125IL	T 10/20	PT 5/16 UNF	L-W 4
TQHR 20-27-TB	120	24	20	2	20	18,5	0,370	✓	TS 50125IL	T 10/20	PT 0.125X8-L5.5	L-W 5
TQHR 25-27-TB	135	-	25	-	25	23,5	0,850	✓	TS 50125IL	T 10/20	PT 0.125X8-L5.5	L-W 5

① = Spanschraube / Clamp screw ② = Schlüssel / Wrench ③ = Stopfen / Plug ④ = Schlüssel / Wrench

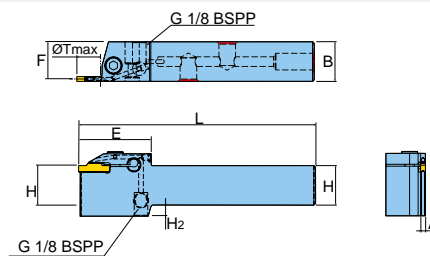
**KLEMMHALTER FÜR AB-, EINSTECHEN UND STECHDREHEN
HIGH PRESSURE TOOL FOR PARTING AND GROOVING**



Artikel-Nr. Designation	L	H	H2	A	B	E	F	Tmax	WSP-S	Gew.	IK
TTEL 2020-2T12-TB	125	20	-	1,8	20	43	19,1	12	2	0,340	✓
TTEL 2525-2T12-TB	150	25	-	1,8	25	43	24,1	12	2	0,680	✓
TTEL 2020-3-TB	125	20	-	2,4	20	43	18,8	12	3	0,355	✓
TTEL 2020-4-TB	125	20	-	3,0	20	46	18,5	15	4	0,350	✓
TTEL 2525-3-TB	150	25	-	2,4	25	43	23,8	12	3	0,700	✓
TTEL 2525-4-TB	150	25	-	3,0	25	46	23,5	15	4	0,670	✓
TTEL 2525-5-TB	150	25	-	4,0	25	49	23,1	20	5	0,670	✓
TTEL 2525-6-TB	150	25	7	5,0	25	52	22,6	20	6	0,770	✓
TTEL 2525-8-TB	150	25	7	6,0	25	58	22,1	25	8	0,070	✓
TTER 2020-2T12-TB	125	20	-	1,8	20	43	19,1	12	2	0,340	✓
TTER 2525-2T12-TB	150	25	-	1,8	25	43	24,1	12	2	0,680	✓
TTER 2020-3-TB	125	20	-	2,4	20	43	18,8	12	3	0,370	✓
TTER 2020-4-TB	125	20	-	3,0	20	46	18,5	15	4	0,350	✓
TTER 2525-3-TB	150	25	-	2,4	25	43	23,8	12	3	0,730	✓
TTER 2525-4-TB	150	25	-	3,0	25	46	23,5	15	4	0,860	✓
TTER 2525-5-TB	150	25	-	4,0	25	49	23,1	20	5	0,650	✓
TTER 2525-6-TB	150	25	7	5,0	25	52	22,6	20	6	0,480	✓
TTER 2525-8-TB	150	25	7	6,0	25	58	22,1	25	8	0,700	✓

Artikel-Nr. Designation				
TTEL 2020-2T12-TB	SH M5x0.8x20	L-W 4	SS M4X0.7X4	PLG G1/8-L6.5
TTEL 2525-2T12-TB	SH M5x0.8x20	L-W 4	SS M4X0.7X4	PLG G1/8-T8.0-L12.3
TTEL 2020-3-TB	SH M5x0.8x20	L-W 4	SS M4X0.7X4	PT 0.125X8-L5.5
TTEL 2020-4-TB	SH M6x1.0x20	L-W 5	SS M4X0.7X4	PT 0.125X8-L5.5
TTEL 2525-3-TB	SH M5x0.8x20	L-W 4	SS M4X0.7X4	PLG G1/8-T8.0-L12.3
TTEL 2525-4-TB	SH M6x1.0x20	L-W 5	SS M4X0.7X4	PLG G1/8-T8.0-L12.3
TTEL 2525-5-TB	SH M6x1.0x20	L-W 5	SS M4X0.7X4	PLG G1/8-T8.0-L12.3
TTEL 2525-6-TB	SH M8X1.25X20	L-W 6	SS M4X0.7X4	PLG G1/8-T8.0-L12.3
TTEL 2525-8-TB	SH M8X1.25X20	L-W 6	SS M4X0.7X4	PLG G1/8-T8.0-L12.3
TTER 2020-2T12-TB	SH M5x0.8x20	L-W 4	SS M4X0.7X4	PLG G1/8-L6.5
TTER 2525-2T12-TB	SH M5x0.8x20	L-W 4	SS M4X0.7X4	PLG G1/8-T8.0-L12.3
TTER 2020-3-TB	SH M5x0.8x20	L-W 4	SS M4X0.7X4	PT 0.125X8-L5.5
TTER 2020-4-TB	SH M6x1.0x20	L-W 5	SS M4X0.7X4	PT 0.125X8-L5.5
TTER 2525-3-TB	SH M5x0.8x20	L-W 4	SS M4X0.7X4	PLG G1/8-T8.0-L12.3
TTER 2525-4-TB	SH M6x1.0x20	L-W 5	SS M4X0.7X4	PLG G1/8-T8.0-L12.3
TTER 2525-5-TB	SH M6x1.0x20	L-W 5	SS M4X0.7X4	PLG G1/8-T8.0-L12.3
TTER 2525-6-TB	SH M8X1.25X20	L-W 6	SS M4X0.7X4	PLG G1/8-T8.0-L12.3
TTER 2525-8-TB	SH M8X1.25X20	L-W 6	SS M4X0.7X4	PLG G1/8-T8.0-L12.3

① = Spannschraube / Clamp screw ② = Schlüssel / Wrench ③ = Verschlusschraube / Clamp screw ④ = Stopfen / Plug



Ingersoll Werkzeuge GmbH ist weltweit präsent – auf Messen und Kongressen der Zerspanungs- und Maschinenindustrie sowie auf Hausmessen führender Maschinenhersteller.

Um den direkten Kontakt zu unseren Kunden intensiver zu gestalten, veranstalten wir in unseren Kundencentern in Haiger und Horrheim/ Deutschland und Rockford/USA spezielle Seminare und anwendungsbezogene Schulungen.

Aktuelle Termine und Informationen zu unseren Seminaren finden Sie unter: www.ingersoll-imc.de und www.ingersoll-imc.com



CUSTOMERS - INTENSIFY CONTACTS



Ingersoll Werkzeuge GmbH is present all over the world - at tool shows and congresses of the milling and machine tool industry as well as at house exhibitions of leading machine tool manufacturers.

To intensify the direct contact to our customers, we organize special seminars and application-specific training courses in our customer centers in Haiger and Horrheim/Germany and Rockford/USA.

Current dates and up-to-date information on our seminars are stated under: www.ingersoll-imc.de and www.ingersoll-imc.com



Ingersoll ist ein weltweit operierender Hersteller von Fräs-, Bohr-, Dreh- und Stechwerkzeugen für die anspruchsvolle Zerspanung.

Von unseren Hauptproduktionsstätten in Haiger und Horrheim in Deutschland sowie in Rockford in den USA werden die internationalen Märkte flächendeckend beliefert. Die Vorortberatung und -betreuung sichert ein Netzwerk an erfahrenen und qualifizierten Vertretungen in über 45 Ländern. Unsere Kunden verfügen somit über das komplette Leistungs- und Servicespektrum von Ingersoll – wo immer sie auch produzieren.



Marketing Standort Haiger (Deutschland)



Marketing office Rockford (USA)

Ingersoll is a worldwide operating manufacturer of milling, boring, threading and turning tools for demanding machining operations.

Our main production plants in Haiger and Horrheim in Germany as well as Rockford in the United States, supply customers all over the world. Experienced and well-trained representatives in over 45 countries ensure a network of on-site advice and assistance. Ingersoll's complete range of performance and service is available to our customers - all over the world.

A large grid of small squares, intended for taking notes. The grid consists of 20 columns and 30 rows of squares, totaling 600 squares. The grid is contained within a rounded rectangular frame.

ALLGEMEINE VERKAUFS- UND LIEFERBEDINGUNGEN

Unsere Leistungen und Lieferungen erfolgen ausschließlich auf der Grundlage unserer Allgemeine Geschäfts- und Lieferbedingungen. Diese sind Vertragsbestandteil. Diese gelten auch für alle künftigen Geschäfte, soweit es sich um solche gleicher Art handelt. Der Kunde bestätigt mit seiner Vertragserklärung zum Abschluss des Vertrags, unsere Allgemeine Geschäfts- und Lieferbedingungen zur Kenntnis genommen zu haben. Der Kunde bestätigt mit seiner Vertragserklärung zum Abschluss des Vertrags, mit der Einbeziehung unserer Allgemeine Geschäfts- und Lieferbedingungen in den Vertrag und mit deren Inhalt Einverstanden zu sein.

Unsere Allgemeine Geschäfts- und Lieferbedingungen können auf unserer Internetseite <https://www.ingersoll-imc.de/> unter dem Gliederungspunkt „Sonstiges“, dort unter der Rubrik „Allgemeine Geschäfts- und Lieferbedingungen“ abgerufen werden. Zudem unterbreiten wir Ihnen hiermit das Angebot zur Übersendung eines Ausdrucks unserer Allgemeine Geschäfts- und Lieferbedingungen.

GENERAL TERMS OF SALE AND DELIVERY

Our services and deliveries are provided exclusively on the basis of our General Terms and Conditions of Business and Delivery. These are a component of the contract. They also apply to all future transactions in as far as these are of the same nature. The client confirms in the contractual declaration upon closing the contract that they have taken note of our General Terms and Conditions of Business and Delivery. The client confirms in the contractual declaration upon closing the contract that they agree to our General Terms and Conditions of Business and Delivery in the contract and their content.

Our General Terms and Conditions of Business and Delivery can be found on our website <https://www.ingersoll-imc.de/en> under the section 'Others' and then under the heading 'General Terms and Conditions'. We also hereby offer to supply a print-out of our General Terms and Conditions of Business and Delivery.

Ingersoll Cutting Tools

Marketing- & Technologie-Standorte

Deutschland

Ingersoll Werkzeuge GmbH

Hauptsitz:

Kalteiche-Ring 21-25

35708 Haiger, Germany

Telefon: +49 2773 742-0

Telefax: +49 2773 742-812

E-Mail: info@ingersoll-imc.de

Internet: www.ingersoll-imc.de

Niederlassung Süd:

Florianstraße 13-17

71665 Vaihingen-Horrheim, Germany

Telefon: +49 7042 8316-0

Telefax: +49 7042 8316-26

E-Mail: horrheim@ingersoll-imc.de

USA

Ingersoll Cutting Tools

845 S. Lyford Road

Rockford, Illinois 61108-2749, USA

Telefon: +1-815-387-6600

Telefax: +1-815-387-6968

E-Mail: info@ingersoll-imc.com

Internet: www.ingersoll-imc.com

France

Ingersoll France

22, rue Albert Einstein

F-77420 CHAMPS-sur-MARNE

Telefon: +33 164684536

Telefax: +33 164684524

E-Mail: info@ingersoll-imc.fr

Internet: www.ingersoll-imc.fr



www.ingersoll-imc.de

